



STANLEY



SARGENT AND GREENLEAF®

Table of Contents

Electronic Safe Locks

Electronic Lock Features Chart	2—3
6120 Model Motorized Electronic Safe Lock	4
6123 Model Motorized Electronic Safe Lock	5
6124 and 6125 Model Motorized Electronic Safe Locks	6
6126 and 6127 Motorized Audit Locks	7
6128 and 6129 A-SERIES™ ATM Locks	8
6300 Model Multiple Compartment Electronic Safe Lock	9
Titan™ PivotBolt™ Safe Lock	10
Titan™ D-Drive™ Safe Lock	11
6550 Model Electronic Vault Lock	12
6140 Model Electronic Door Lock	13
Keypads for Electronic Locks	14—15
Accessories for Electronic Safe Locks	16—17
2740 High Security Safe Lock for GSA Applications	18
2890 PDL High Security Pedestrian Door Lock	19
Mechanical Safe Locks	
Mechanical Safe Lock Features Chart	20
Group 2 Mechanical Safe Locks	21
Group 2M Mechanical Safe Locks	22
Dials and Rings for Group 2 and Group 2M Locks	23
Group 1 and Group 1R Mechanical Safe Locks	24
Group 1 Model 2937 Mechanical Safe Lock	25
Parts and Accessories for Mechanical Safe Locks	26
Time Locks and Time Movements	27
Mechanical Vault Locks	28
Key-Op® Key Operated Safe Locks	29
Safe Handle	29
6870 Model Key Operated Safe Lock	30
Safe Deposit Locks	
4200 and 4400 Series Safe Deposit Locks	31

4500 Series Safe Deposit Locks	32
4100 Series Cabinet Locks	32
Key Blanks for Safe Deposit and Cabinet Locks	33

Padlocks

8077AD Model Combination Padlock	34
951C Model High Security Padlock	34
Extension 50 Model Mechanical Automatic Door Deadbolts	35
Sliding Mechanical Deadbolts	35
The Brute® Electronic Door Deadlatch	36
Product Compliance and Certification	36

Panic Exit Devices

Arm-A-Dor® Secure Panic Exit Hardware	37
---	----

Technical Specifications

6120 and 6123 Model Case Dimensions	38
6124, 2126, 6128, 6300 Model Case Dimensions	38
6125, 6127, 6129 Model Case Dimensions with Switch and Bolt Travel Information	39
Titan™ PivotBolt™ Case Dimensions	40
Titan™ D-Drive™ Case Dimensions	40
6550 Model Electronic Vault Lock Case Dimensions	41
Mechanical Lock Case Dimensions	42
Mechanical Lock Bolt Variations	43
Mechanical Vault Lock Case Dimensions	44
Spacings and Depths for Safe Deposit Lock Keys	45
4200 and 4400 Series Safe Deposit Lock Dimensions	46
4100 Series Cabinet Lock Dimensions	47
4500 Series Safe Deposit Lock Dimensions	47

Warranty Statement	48
------------------------------	----

STANLEY, STANLEY in a notched rectangle, SARGENT AND GREENLEAF, S&G, Manipulation Proof MP, A-SERIES, D-DRIVE, TITAN, PivotBolt, KEY-OP, THE BRUTE, ARM-A-DOR, and SPY-PROOF are some of the trademarks of Stanley Black and Decker or its affiliates.

Windows is a trademark of Microsoft Corporation.

Dallas and iButton are trademarks of Dallas Semiconductor Corporation.

Zamak is a trademark of Horsehead Corp.

Delrin is a trademark of E.I. DuPont de Nemours and Company.

Medeco is a trademark of Medeco High Security Locks.

Corbin is a trademark of Corbin Russwin Inc.

Yale is a trademark of Yale Security Inc.

Diebold and Mosler are trademarks of Diebold, Incorporated.

Electronic Lock Features Chart



	6120 SERIES	6123 SERIES	6124 SERIES IN MULTI-USER MODE	6124 SERIES IN DUAL USER MODE	6125 SERIES IN MULTI-USER MODE	6125 SERIES IN DUAL USER MODE	6126 SERIES AUDIT LOCK	6127 SERIES AUDIT LOCK	6128 A-SERIES™	6129 A-SERIES™	6300 SERIES
UL Listed Type 1	✓	✓	✓	✓	✓	✓	✓	✓	✓	✓	✓
CEN B			✓	✓	✓	✓	✓	✓	✓	✓	
VdS Class 2			✓	✓	✓	✓	✓	✓	✓	✓	
A2P B/E			✓	✓	✓	✓	✓	✓	✓	✓	
DNV 3492			✓	✓	✓	✓	✓	✓			
Multiple User Mode	✓	✓	✓		✓		✓	✓	✓	✓	✓
Dual User Mode		✓	CHANGEABLE TO DUAL USER MODE	✓	CHANGEABLE TO DUAL USER MODE	✓	✓	✓	✓	✓	✓
Manager/Employee Mode		✓	INCLUDED WITH MULTIPLE USER CONFIGURATION		INCLUDED WITH MULTIPLE USER CONFIGURATION		✓	✓	✓	✓	✓
Management Reset Code (MRC)	✓	✓	✓		✓		ORDER 6126-146	ORDER 6127-246			
Programmer Code							✓	✓	✓	✓	✓
Master Code	✓	✓	✓	✓	✓	✓	✓	✓			
Officer Code(s)									2	2	
Administrator Code(s)									4	4	
Manager Code							3	3			
Supervisor Code		1	1	1	1	1	6	6			2
User Codes	8	5	7 (3 WHEN DURESS IS ENABLED)**	8	7 (3 WHEN DURESS IS ENABLED)**	8	20	20	10	10	18
Total No. of Codes*	9	7	9**	9	9**	9	29	29	16	16	20
Duress Capability			ORDER DURESS MODULE 6102-090	ORDER DURESS MODULE 6102-090	ORDER DURESS MODULE 6102-090	ORDER DURESS MODULE 6102-090	ORDER DURESS MODULE 6102-090	ORDER DURESS MODULE 6102-090	ORDER DURESS MODULE 6102-090	ORDER DURESS MODULE 6102-090	✓
Time Delay	1-9 Min.	1-99 Min.	1-99 Min.	1-99 Min.	1-99 Min.	1-99 Min.	1-99 Min.	1-99 Min.	1-99 Min.	1-99 Min.	1-99 Min.
Time Delay Override Code		✓	✓	✓	✓	✓					✓
Time Lock (7-Day Repeating Schedule)											✓
Penalty Lockout Feature	✓	✓	✓	✓	✓	✓	✓	✓	✓	✓	✓
Bolt Position Indicator	ORDER 6120-323	ORDER 6123-312	ORDER 6124-225	ORDER 6124-225	ORDER 6125-223	ORDER 6125-233	ORDER 6126-242	ORDER 6127-242	ORDER 6128-230	ORDER 6129-230	✓
Compatible with Biometric Keypad***	✓	✓									
Locking Mechanism	MOTOR DRIVE	MOTOR DRIVE	MOTOR DRIVE	MOTOR DRIVE	MOTOR DRIVE	MOTOR DRIVE	MOTOR DRIVE	MOTOR DRIVE	MOTOR DRIVE	MOTOR DRIVE	MOTOR DRIVE

* Includes only codes that can be used to open the lock, but does not include special-purpose time delay override code(s) that may be available. Codes used only for programming and/or audit trail management are not included in this number.

** If time delay override is not enabled, an additional user code is available, bringing the maximum number of user codes to 9 (8 codes are available if time delay override is enabled), with 3 of these available when the duress function is enabled.

Electronic Lock Features Chart



TITAN™ D-DRIVE™ ELECTRONIC LOCK



TITAN™ PIVOTBOLT™ ELECTRONIC LOCK

	TITAN™ PIVOTBOLT™ IN MULTI-USER MODE	TITAN™ PIVOTBOLT™ IN DUAL USER MODE	TITAN™ D-Drive™ IN MULTI-USER MODE	TITAN™ D-Drive™ IN DUAL USER MODE
UL Listed Type 1	✓	✓	✓	✓
CEN B	✓	✓	✓	✓
VdS Class 2	✓	✓	✓	✓
A2P B/E	✓	✓	✓	✓
DNV 3492	✓	✓	✓	✓
Multiple User Mode	✓		✓	
Dual User Mode	✓	✓	✓	✓
Manager/Employee Mode	✓		✓	
Management Reset Code (MRC)	✓		✓	
Programmer Code				
Master Code	✓	✓	✓	✓
Officer Code(s)				
Administrator Code(s)				
Manager Code				
Supervisor Code	1	1	1	1
User Codes	7	7	7	7
Total No. of Codes*	9**	9	9**	9
Duress Capability	ORDER DURESS MODULE 6102-090	ORDER DURESS MODULE 6102-090	ORDER DURESS MODULE 6102-090	ORDER DURESS MODULE 6102-090
Time Delay	1-99 Min.	1-99 Min.	1-99 Min.	1-99 Min.
Time Delay Override Code	✓	✓	✓	✓
Time Lock (7-Day Repeating Schedule)				
Penalty Lockout Feature	✓	✓	✓	✓
Bolt Position Indicator	ORDER BPI KIT 2006-201	ORDER BPI KIT 2006-201	ORDER BPI KIT 2006-201	ORDER BPI KIT 2006-201
Compatible with Biometric Keypad				
Locking Mechanism	MOTOR DRIVE	MOTOR DRIVE	MOTOR DRIVE	MOTOR DRIVE

* Includes only codes that can be used to open the lock, but does not include special-purpose time delay override code(s) that may be available. Codes used only for programming are not included in this number.

** If time delay override is not enabled, an additional user code is available, bringing the maximum number of user codes to 9 (8 codes are available if time delay override is enabled), with 3 of these available when the duress function is enabled.

6120 Series Motorized Electronic Safe Lock

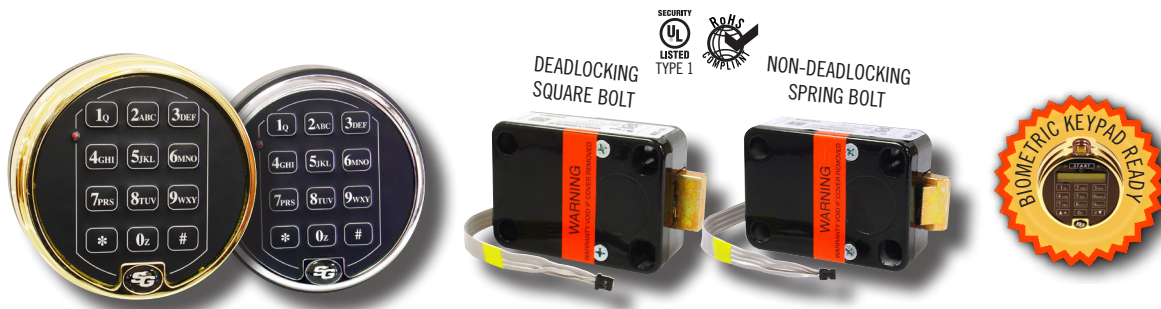

- Underwriters Laboratories Listed Type 1, and RoHS (Reduction of Hazardous Substances) compliant.
- A motor-driven lock bolt offers a high level of security by eliminating the threat of vibration and bouncing attacks.
- Management reset code, one master code, and eight user codes.
- Management reset code (MRC) restores the lock to its original factory code if the master code is lost.
- Time delay up to 9 minutes.
- The 6120 Series incorporates a penalty time feature to prevent opening by entering sequential or random codes until a valid code is found.
- All programming is quickly and easily done via the keypad (no separate programming equipment required).
- The deadlocking square bolt model withstands 225 lbs. (1000 newtons) of bolt end pressure for a high level of security and durability in boltwork blocking applications.
- Non-deadlocking spring bolt model is designed for lightweight and inner compartment doors that require the lock to latch and secure the door.
- Can be used with the Biometric Keypad, 2-battery keypad, standard 1-battery keypad, and the non-rotating low profile keypad.

Lock Bodies (only)

Square Bolt—Order Number	Latch Bolt—Order Number	Management Reset Code	Keypad
6120-309	6120-502	field settable	order separately below
6120-308	6120-504	factory set	order separately below

Keypads (only)



Two-Battery Keypads	Bezel Finish
6120-010	buffed brass
6120-012	buffed chrome
6120-014	matte black
6120-016	satin chrome
6120-045	24k gold
6120-046	14k gold

Biometric Keypads	Bezel Finish
6120-410	buffed chrome
6120-411	satin chrome
6120-412	buffed brass
6120-413	24 karat gold



One-Battery Keypads	Bezel Finish
6120-210	buffed chrome
6120-211	buffed brass



Non-Rotating Low Profile Keypads	Bezel Finish
6130-400	buffed chrome



Locks with Keypads

Order Number	Lock Type	Keypad	Notes
6120-301	square bolt	2-battery buffed brass	batteries not included
6120-302	square bolt	2-battery buffed chrome	batteries not included
6120-303	square bolt	2-battery matte black	batteries not included
6120-305	square bolt	2-battery satin chrome	includes (2) 9-volt batteries
6120-329	square bolt	1-battery chrome	includes (1) 9-volt battery
6120-330	square bolt	1-battery brass	includes (1) 9-volt battery
6120-508	spring bolt	2-battery satin chrome	batteries not included

6123 Series Motorized Electronic Safe Lock

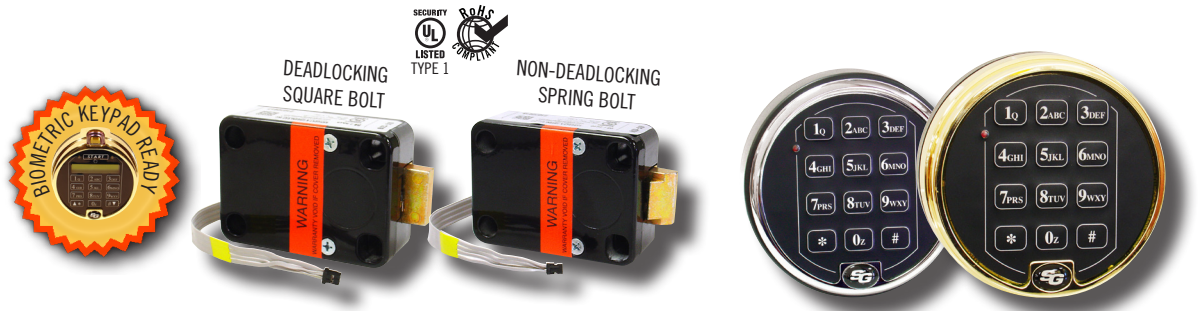

- Underwriters Laboratories Listed Type 1, and RoHS (Reduction of Hazardous Substances) compliant.
- A motor-driven lock bolt offers a high level of security by eliminating the threat of vibration and bouncing attacks.
- Management reset code, one master code, one supervisor code, five user codes, and one time delay override code.
- Management reset code (MRC) restores the lock to its original factory code if the master code is lost.
- Time delay up to ninety-nine minutes, and three modes of operation (single control, dual control, and manager/employee mode).
- The 6123 Series incorporates a penalty time feature to prevent opening by entering sequential or random codes until a valid code is found.
- All programming is quickly and easily done via the keypad (no separate programming equipment required).
- The deadlocking square bolt model withstands 225 lbs. (1000 newtons) of bolt end pressure for secure locking in boltwork blocking applications.
- Non-deadlocking spring bolt model is designed for lightweight and inner compartment doors that require the lock to latch and secure the door.
- Can be used with the Biometric Keypad, 2-battery keypad, standard 1-battery keypad, and the non-rotating low profile keypad.

Lock Bodies (only)

Square Bolt Order Number	Latch Bolt Order Number	Management Reset Code	Keypad
6123-301		field settable	none (lock only)
6123-310	6123-501	factory set	none (lock only)

Keypads (only)

Two-Battery Keypads	Bezel Finish
6120-010	buffed brass
6120-012	buffed chrome
6120-014	matte black
6120-016	satin chrome
6120-045	24k gold
6120-046	14k gold



Biometric Keypads	Bezel Finish
6120-410	buffed chrome
6120-411	satin chrome
6120-412	buffed brass
6120-413	24 karat gold



One-Battery Keypads	Bezel Finish
6120-210	buffed chrome
6120-211	buffed brass



Non-Rotating Low Profile Keypads	Bezel Finish
6130-400	buffed chrome



Locks with Keypads

Order Number	Lock Type	Keypad	Notes
6123-303	square bolt	2-battery satin chrome	batteries not included
6123-304	square bolt	2-battery buffed chrome	batteries not included
6123-307	square bolt	2-battery matte black	batteries not included
6123-505	spring bolt	2-battery satin chrome	batteries not included

6124 and 6125 Series Motorized Electronic Safe Locks

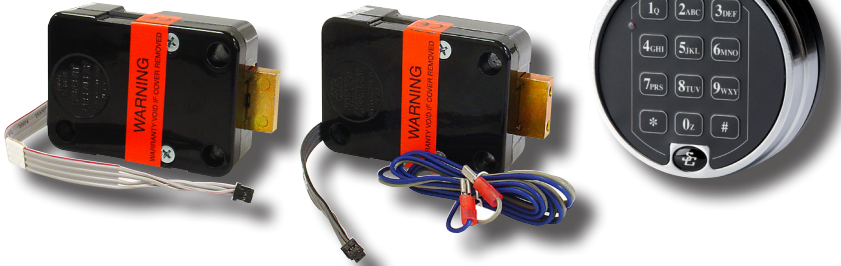

- Underwriters Laboratories Listed Type 1, CEN B, VdS Class 2, A2P B/E, DNV 3492, and RoHS compliant.
- Both locks feature a motor-driven lock bolt which offers a high level of security by eliminating the threat of vibration and bouncing attacks.
- The multiple user mode provides for a management reset code. The dual user mode does not provide for a management reset code.
- Both models offer one master code, one supervisor code, seven user codes, and one time delay override code.*
- Multiple user mode—Any of the lock's codes can be used to open. Multiple user can also be switched to Manager/Employee mode, in which the master and supervisor codes toggle the lock on and off for operation by the holders of user codes.
- Dual user mode—The standard multiple user lock can be permanently switched to dual user mode at setup, before the master code is changed for the first time. Then the lock can only be opened if two separate codes are entered within one minute of each other. This provides a higher level of access control.
- A penalty time feature to is provided to prevent opening by entering sequential or random codes until a valid code is found.
- A delay up to 99 minutes can be easily set, and provides for one time delay override code for cash carrier applications.
- The lock offers a duress capability, allowing a distress signal to be sent through the customer's central alarm system in the event of an emergency. An optional duress module (part #6102-090) is required to use this function.
- The 6124 Series is designed for boltwork blocking applications that do not require direct attachment of the lock bolt to the safe's boltwork.
- The 6125 Series is made for direct boltwork attachment and will push and pull 2.24 lbs. (10 newtons)—maximum load 5.6 lbs. (25 newtons).
- Some models are equipped with a bolt position indicator that closes a circuit when the lock bolt is in either the locked or unlocked position (see part number table below).

* If a multiple user lock has the duress feature enabled, User PINs 4 through 8 are automatically disabled and are not available. A dual user lock always has all codes available for use. In both models, the time delay override code uses PIN 9. If time delay override is disabled, PIN 9 functions like a standard user code.

Lock Bodies (only)

6124 Order Number	6125 Order Number	Configuration	Management Reset Code	Time Delay	Time Delay Override	Bolt Position Indicator	Duress
6124-143	6125-138	multiple user	yes ²	1-99 min	yes	no	yes ¹
6124-238	6125-237	multiple user	yes ²	1-99 min	yes	yes	yes ¹

¹Duress requires an optional duress module (part #6102-090).

²If the lock is switched to dual user mode, the Management Reset Code is not available.

These locks come with both M6 and ¼-20 mounting screws.

Keypads (only)

Two-Battery Keypads	Bezel Finish	Tamper Indicating	Notes
61KP-105	satın chrome	no	maintains U.L. Listing
61KP-202	satın chrome	yes	maintains all ratings

6126 and 6127 Series Motorized Audit Lock

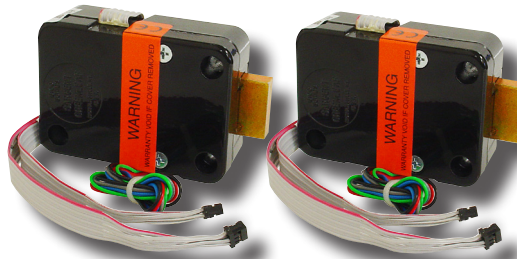

- Underwriters Laboratories Listed Type 1, CEN B, VdS Class 2, A2P B/E, DNV 3492, and RoHS compliant.
- Both models feature a motor-driven lock bolt which offers a high level of security by eliminating the threat of vibration and bouncing attacks.
- Up to thirty users—Both models offer one programmer code, three manager codes, six supervisor codes, and twenty user codes.
- Multiple User, Dual Control, and Manager/Employee modes selectable and changeable at any time.
- 400-event, time and date stamped audit trail managed by easy-to-use PC-based software. To download audit trail data from the lock, you will need the optional audit trail software kit (part #6103-130 or 6103-131).
- Both models incorporate a penalty time feature to prevent opening by entering sequential or random codes until a valid code is found.
- Both models offer time delay up to 99 minutes.
- Both models offer a duress capability, allowing a distress signal to be sent through the customer's central alarm system in the event of an emergency. An optional duress module (part #6102-090) is required to use this function.
- The 6126 Audit Lock is designed for boltwork blocking applications that do not require direct attachment of the lock bolt to the safe's boltwork.
- The 6127 Audit Lock is designed for direct boltwork attachment and will push and pull 2.24 lbs. (10 newtons), with a maximum load of 5.6 lbs. (25 newtons).
- Some models are equipped with a bolt position indicator that closes a circuit when the lock bolt is in either the locked or unlocked position (see part number table below).

Locks and Lock Kits

6126 Audit Lock Order Number	6127 Audit Lock Order Number	Keypad	Keypad Extension Included	Bolt Position Indicator Included	Management Reset Code
6126-142		yes	yes	no	no
6126-242	6127-242	yes	yes	yes	no
6126-146	6127-146	yes	yes	no	yes
6126-246	6127-246	yes	yes	yes	yes



SG Audit Software runs on Windows® XP, Windows® 7, Windows® Server 2008, and Windows® Vista operating systems. It includes a cable with a Dallas® key reader and a Dallas® iButton® for transferring the audit information from the lock to your computer. Check your computer to see whether you will need the serial adapter or USB adapter. The appropriate driver software is included with each type of adapter. The keypad extension base and audit trail software kit are both needed to download, view, and manage time and date-stamped audit information captured by a 6126, 6127, 6128, or 6129 lock.

- 6103-130—Audit trail software on CD, serial adapter with cable, and Dallas® iButton®.
- 6103-131—Audit trail software on CD, USB adapter with cable, and Dallas® iButton®.
- 6103-102—Key reader with USB adapter with cable only.
- 6104-006—Extra Dallas® iButton® (red fob).
- 6102-025—Alarm interface module for 6126, 6127, 6128, and 6129.

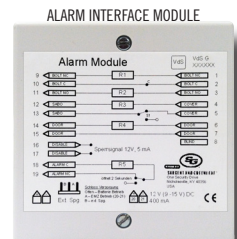

SARGENT AND GREENLEAF®

A Subsidiary of Stanley Security Solutions, Inc.

6128 and 6129 A-SERIES™ ATM Locks

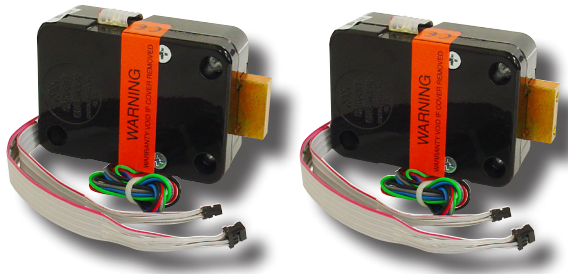

- Underwriters Laboratories Listed Type 1, VdS Class 2, CEN B, A2P B/E, and RoHS compliant.
- Both models feature a motor-driven lock bolt which offers a high level of security by eliminating the threat of vibration and bouncing attacks.
- Up to sixteen users in *Bank Mode*—One programmer code, two officer codes, four administrator codes, and ten user codes.
- Dual Control and Manager/Employee modes selectable and changeable at any time by entering a special keypad command.
- 400-event, time and date stamped audit trail managed by easy-to-use PC-based software. To read audit trail information, you will need the optional audit trail software kit (part #6103-120). Time, date, and event duration information is generated and stored in the lock so that it is not susceptible to time drift.
- Snap-in touch key reader allows fast, accurate transfer of audit trail data.
- Both models incorporate a penalty time feature to prevent opening by entering sequential or random codes until a valid code is found.
- Both models offer time delay of one to ninety-nine minutes.
- Both models offer a duress capability, allowing a distress signal to be sent through the customer's central alarm system in the event of an emergency. A *duress module* (part #6102-090) or *alarm interface module* (part #6102-025) is required to use this function.
- The 6128 A-SERIES™ Lock is made for boltwork blocking applications that do not require direct attachment of the lock bolt to the safe's boltwork.
- The 6129 A-SERIES™ Lock is designed for direct boltwork attachment and will push and pull 2.24 lbs. (10 newtons), with a maximum load of 5.6 lbs. (25 newtons).
- All models are equipped with a bolt position indicator that closes a circuit when the lock bolt is in either the locked or unlocked position.
- Both models can be opened via Dallas® iButton® keys in conjunction with *one time codes* (OTC) when *service mode* is enabled. Contact a Sargent & Greenleaf sales representative (800 826-7652) for information about *service mode* and LMS software.

Lock Kits—lock, keypad, keypad extension, serial number plate

6128 A-SERIES™ Order Number	6129 A-SERIES™ Order Number	Non-Tamper Keypad	Keypad Extension	Bolt Position Indicator	Reset Code
6128-240	6129-240	yes	yes	yes	no



SERIAL ADAPTER/CABLE



USB ADAPTER/CABLE

SG Audit Software runs on Windows® XP, Windows® 7, Windows® Server 2008, and Windows® Vista operating systems. It includes a cable with a Dallas® key reader and a Dallas® iButton® for transferring the audit information from the lock to your computer. Check your computer to see whether you will need the serial adapter or USB adapter. The appropriate driver software is included with each type of adapter. The keypad extension base and audit trail software kit are both needed to download, view, and manage time and date-stamped audit information captured by a 6126, 6127, 6128, or 6129 lock.

- 6103-130—Audit trail software on CD, serial adapter with cable, and Dallas® iButton®.
- 6103-131—Audit trail software on CD, USB adapter with cable, and Dallas® iButton®.
- 6103-102—Key reader with USB adapter with cable only.
- 6104-006—Extra Dallas® iButton® (red fob).
- 6102-025—Alarm interface module for 6126, 6127, 6128, and 6129.
- 6128-500—A-SEAL box with 9-volt battery.



A-SEAL BOX

6300 Series Multiple Compartment Electronic Safe Lock

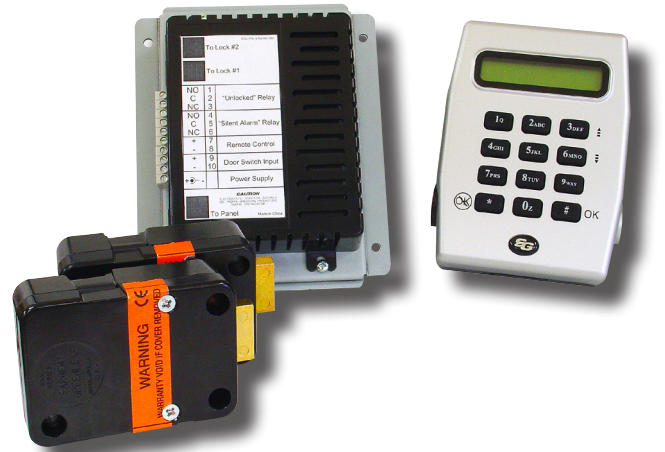

- Three different field-settable modes of operation—multiple user, dual control, and manager/employee mode.
- Many features are programmable from the keypad. Access more features and make programming easier with the 6350-001 software kit.
- Keypad LCD displays text in English or Spanish.
- One programmer code, two supervisor codes, eighteen user codes.
- Select six, seven, or eight-digit code format for up to 100,000,000 different code possibilities.
- Time delay from 1 to 99 minutes.
- Assign time delay override authority to any code holder(s).
- Full function seven-day repeating time lock schedule with up to 27 special holiday overrides.
- Make any user subject to dual control with another code holder or make any user present a registered touch key to the keypad when entering a code to operate the lock.
- Penalty lockout feature to prevent opening by entering sequential or random codes until a valid code is found.
- Duress capability is standard and built into the control unit.
- Keypad and control unit operate one or two locks independently.
- Bolt position indicator available by special request.
- 500-event time and date stamped audit trail managed by easy-to-use PC-based software (purchase separately), or view audit events on the LCD keypad.
- Remote enable connections are built into the control unit.
- Powered by an AC plug-in transformer, with battery backup capability built in.

6300 Components

Order Number	Components	Description
6352-004	keypad and control unit	2-line LCD keypad and 6300 control unit
6160-101	120-volt power supply	plug-in transformer for 120-volt AC mains
6354-005	square bolt lock	lock body with attached cable
6350-001	software kit	lock programming and audit trail management software/hardware

6350-001—Software kit with included touch keys and serial interface reader/cable.

6103-102—USB adapter with cable only.



SARGENT AND GREENLEAF®

A Subsidiary of Stanley Security Solutions, Inc.

Titan™ PivotBolt™ Safe Lock

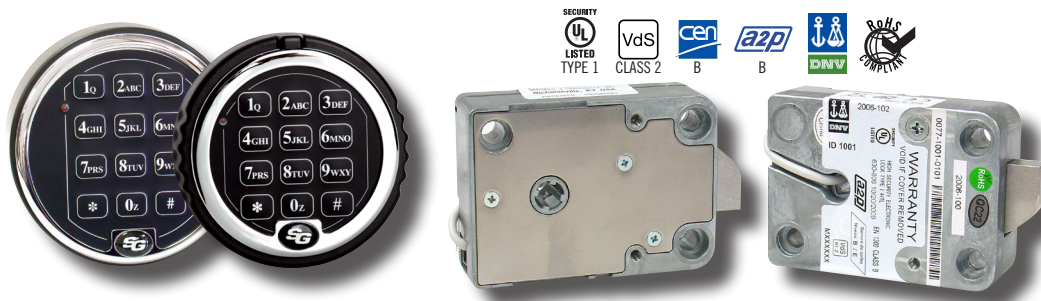

- Underwriters Laboratories Listed Type 1, VdS Class 2, CEN B, A2P B, DNV, and RoHS (Reduction of Hazardous Substances) compliant.
- The Titan™ PivotBolt™ lock features a new design, motor driven locking mechanism for an extra measure of security and longer battery life.
- Lock bolt retraction and extension is controlled by the movement of the safe's boltwork.
- The Titan™ PivotBolt™ automatically locks to re-secure the safe whenever the container's boltwork moves to the fully closed position, discouraging the common (non-secure) practice of day-locking.
- The Titan™ PivotBolt™ is connected to the keypad only by cable, which means the lock does not need to be placed directly behind the keypad. It can be located anywhere on the inside of the safe door.
- All PivotBolt models use the standard S&G Magic Module footprint, allowing for easy retrofit without the need for boltwork or mounting screw location changes. Plus, it's universally handed and reversible for RH, LH, VU, and VD mounting.
- Three modes of operation: Multi-User, Manager/Employee, Dual Control.
- Management reset code, one master code, one supervisor code, eight user codes, and one time delay override code*. The management reset code (MRC) lets you set a new master code of your own choosing if the old master code is lost or forgotten.
- The Titan™ PivotBolt™ has a penalty time feature to prevent opening by entering sequential or random codes until a valid code is found.
- All programming is quickly and easily done via the keypad (no separate programming equipment required).
- The lock bolt model withstands 225 lbs. (1000 newtons) of bolt end pressure for a high level of security in boltwork blocking applications.
- Can be used with the S&G 2-battery keypad, standard 1-battery keypad, or the non-rotating low profile keypad.

* When a time delay override code is set, the number of available user codes is seven. If the lock is set to multiple user mode and duress is turned on, only User Codes 2 and 3 are available. User Codes 4 – 8 are disabled. User Code 9 will be available to use if time delay override is not enabled. Loss of User Codes when duress is enabled is required to meet EN1300 specifications for this product. If the lock is set to dual user mode, all codes always remain available.

Part Number	Description
2006-100	Titan™ PivotBolt™ lock body with cable (no keypad)
2006-102	Titan™ PivotBolt™ lock, cable, and a 6130-400 keypad

2006-201—Bolt Position Indicator (BPI)

This optional accessory consists of a special single pole, double throw switch designed to fit into an existing cavity under the Titan's removable front cover. The color-coded leads are already connected. Now your lock can trigger alarms, CCTV recorders, or virtually any relay activated device.

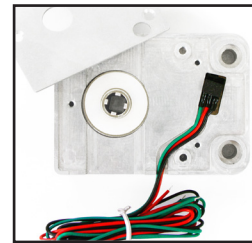

Keypads (only)

One-Battery Keypads	Bezel Finish	Two-Battery Keypads	Bezel Finish
6120-210	buffed chrome	6120-010	buffed brass
6120-211	buffed brass	6120-012	buffed chrome
		6120-014	matte black
		6120-016	satın chrome
		6120-045	24k gold
		6120-046	14k gold



Titan™ D-Drive™ Safe Lock

SIMPLIFIED NON-SOLENOID BLOCKING DESIGN FOR HIGH DEPENDABILITY

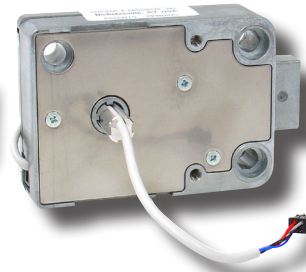
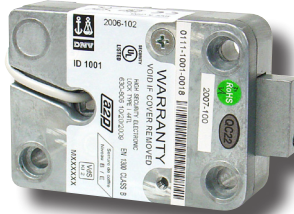
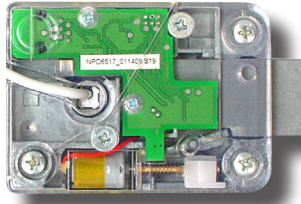

- Underwriters Laboratories Listed Type 1, VdS Class 2, CEN B, A2P B, DNV, and RoHS (Reduction of Hazardous Substances) compliant.
- The Titan™ D-Drive™ lock features a new design, motor driven locking mechanism for an extra measure of security and longer battery life.
- Lock bolt retraction and extension is controlled by turning of the keypad, offering dependable manual control of the locking bolt. And the sure-grip, low profile keypad gives a good, solid feel for the action of the lock.
- The Titan™ D-Drive™ uses an exclusive, no-twist cable design that virtually eliminates the risk of cable damage due to keypad rotation. The cable is located in a recessed channel in the lock's extruded aluminum spindle, safely out of harm's way.
- The Titan™ D-Drive™ uses the standard S&G Magic Module footprint, allowing for easy retrofit without the need for boltwork or mounting screw location changes. Plus, it's universally handed for RH, LH, VU, and VD mounting.
- Three modes of operation:

Multi-User—The Master Code, Supervisor Code, and any User Code can open the lock with a single code.

Manager/Employee—Code holders can access the safe only when it's been enabled by a Master Code or Supervisor Code holder.

Dual Control—Multi-User mode is the factory default, but Dual Control is keypad selectable as an alternate, permanent mode of operation. Two different lock codes must be entered within one minute of each other to open the safe. This provides a higher level of security.

- Management reset code, one master code, one supervisor code, eight user codes, and one time delay override code*. The management reset code (MRC) lets you set a new master code of your own choosing if the old master code is lost or forgotten.
- The Titan™ D-Drive™ has a penalty time feature to prevent opening by entering sequential or random codes until a valid code is found.
- All programming is quickly and easily done via the keypad (no separate programming equipment required).
- The lock bolt model withstands 225 lbs. (1000 newtons) of bolt end pressure for a high level of security in boltwork blocking applications.
- An easy to install bolt position sensor switch can be added to trigger alarms, CCTV recorders, or virtually any relay activated security device.

* When a time delay override code is set, the number of available user codes is seven. If the lock is set to multiple user mode and duress is turned on, only User Codes 2 and 3 are available. User Codes 4 – 8 are disabled. User Code 9 will be available to use if time delay override is not enabled. Loss of User Codes when duress is enabled is required to meet EN1300 specifications for this product. If the lock is set to dual user mode, all codes always remain available.

Part Number	Description
2007-100	Titan™ D-Drive™ lock body with cable (no keypad or spindle)
2007-102	Titan™ D-Drive™ lock, cable, spindle, keypad
2004-500	Aluminum spindle only—8 inches (20.3 cm)
6130-200	Rotating keypad only

2006-201—Bolt Position Indicator (BPI)

This optional accessory consists of a special single pole, double throw switch designed to fit into an existing cavity under the Titan's removable front cover. The color-coded leads are already connected. Now your lock can trigger alarms, CCTV recorders, or virtually any relay activated device.

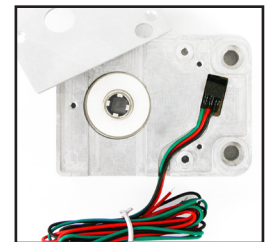

2004-700—Add extra boltwork attachment points to any Titan™ D-Drive™ lock with "wings." Ideal for lightweight safes without bolt control handles. Pushes and pulls 2.5 lbs. (11.12 Newtons). Part number 2004-700 is for a pair of wings.



Electronic Vault Lock

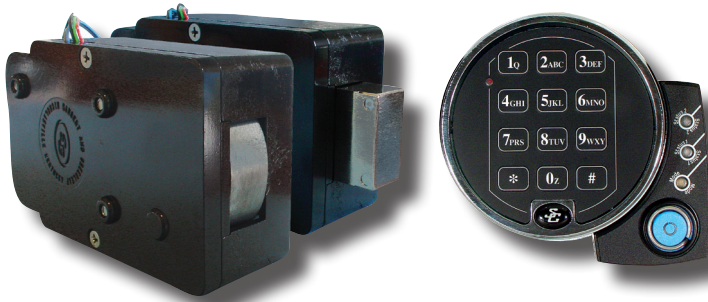

BRINGING THE SECURITY AND CONVENIENCE OF ELECTRONIC LOCKS TO VAULT APPLICATIONS

- Same mounting footprint as the S&G® 6400 and 6500 series mechanical vault locks for quick, easy retrofit in most applications. Replaces both direct and indirect drive units.
- Automatically locks when the safe or vault door is closed and the boltwork is thrown.
- Powered by a model 6127 push/pull Audit Lock that is Underwriters Laboratories Listed Type 1, VdS Class 2, CEN B, A2P B/E, DNV 3492, and RoHS compliant.
- Heavy duty motor-driven lock bolt offers a high level of security by eliminating the threat of vibration and bouncing attacks.
- Up to thirty users—one programmer code, three manager codes, six supervisor codes, and twenty user codes.
- Multiple User, Dual Control, and Manager/Employee modes selectable and changeable at any time via the keypad.
- 400-event, time and date stamped audit trail managed by easy-to-use PC-based software. To read audit trail information, you will need the optional audit trail software kit (part #6103-130 or 6103-131).
- Snap-in touch key reader allows fast, accurate transfer of audit trail data.
- Penalty time feature prevents opening by entering sequential or random codes until a valid code is found.
- Time delay up to 99 minutes.
- Duress capability allows a distress signal to be sent through the customer’s central alarm system in the event of an emergency. An optional duress module (part #6102-090) is required to use this function.
- Built in bolt position indicator closes a circuit when the lock bolt is in either the locked or unlocked position (see part number table below) to trigger any relay-activated device.
- Recommended only for applications that include a secondary lock override or separate service door.

Electronic Vault Locks

Order Number	Description
6550-112	roller bolt electronic vault lock with two-battery keypad and keypad extension (for reading audit trail)
6550-113	square bolt electronic vault lock with two-battery keypad and keypad extension (for reading audit trail)



6140 Series Electronic Door Lock



- Same mounting footprint and strikes as the mechanical S&G® Extension 50 automatic door lock.
- Powered by a model 6123 UL Listed Type 1 electronic safe lock.
- One master code, one supervisor code, five user codes, one time delay override code, three different operating modes (multiple user, dual user, manager/employee mode)
- Motor-driven lock design offers a high level of security by eliminating the threat of vibration and bouncing attacks.
- Penalty time feature prevents opening by entering sequential or random codes until a valid code is found.
- Door locks automatically whenever it closes—automatic security for secure rooms and restricted areas.
- Inside release knob is always active for normal or emergency exit.
- Time delay—up to 99 minutes.
- All 6140 models are 100% compatible with the S&G® Biometric Keypad—add the security and convenience of fingerprint recognition technology to your 6140 door lock (purchase separately). The standard two-battery keypad 61KP-105 is also recommended for use with the 6140 door lock. See keypad information on the following page.
- Three different heavy duty strikes are available to suit virtually all door and frame applications.
- Some models are equipped with a bolt position indicator that provides connections for both normally open and normally closed circuits. This feature can be used to activate video recording equipment or any relay-activated device whenever the lock is opened from either the inside or the outside. Switch rating is 200 VDC @ 0.5 amp.

6140 Door Lock

Order Number	Included Strike(s)
6140-003	#1 and #3 for in-swing doors
6140-004	#2 for out-swing doors

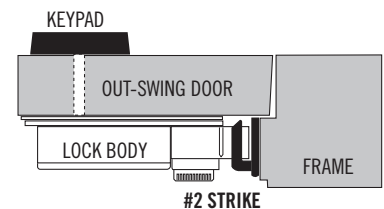
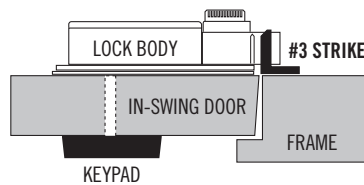
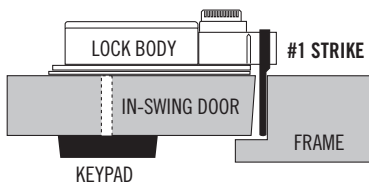

Electronic Lock Keypads



The **Biometric Keypad** uses advanced fingerprint recognition technology to add extra security and convenience to any 6120, 6123, or 6140 door lock. Install it with a new lock, or use it as an easy retrofit upgrade to an existing lock. It can be set to open a lock with fingerprint or code, or require both.

Part #6120-410 Buffed chrome finish

Part #6120-411 Satin chrome finish

Part #6120-412 Buffed brass finish

Part #6120-413 24 karat gold finish



The **Time Lock Keypad** adds the security and convenience of a fully programmable seven-day repeating schedule time lock to 6124, 6125, 6126, 6127, and Titan™ PivotBolt™ electronic locks. The easy to read LCD screen displays in English, Spanish, Portuguese, German, or Italian. Set one or two time lock periods per day, with up to twenty special holidays and up to fifteen vacation periods that will override the repeating time lock schedule when needed. Automatic adjustment for Daylight Savings Time once the beginning and ending dates have been set.

Part #6120-420 Satin chrome finish



The standard two-battery keypad can be used with lock models 6120, 6123, Titan™ PivotBolt™, and the 6140 door lock.

Part #6120-010 Buffed brass finish

Part #6120-012 Buffed chrome finish

Part # 6120-014 Matte black finish

Part # 6120-045 24 karat gold finish

Part # 6120-046 14 karat gold finish

Part # 6120-016 Satin chrome finish



The **61KP-105** two-battery keypad is generally used with 6124, 6125, 6126, 6127, 6128, and 6129 locks. It can also be used with 6120, 6123, Titan™ PivotBolt™, and the 6140 door lock.

The **61KP-201** is a tamper indicating keypad that is used exclusively with lock models 6124 and 6125 to meet German VdS specifications. The 61KP-105 should be used for non-VdS applications.

Part #61KP-105 Satin chrome finish

Part #61KP-202 Satin chrome finish

The one-battery keypad is ideal for use with 6120, 6123, and Titan™ PivotBolt™ locks. The battery is kept in an easy-to-access battery compartment at the bottom of the keypad. The one-battery keypad is designed to let you change the battery quickly and easily.

Part #6120-210 Buffed chrome trim ring

Part #6120-211 Buffed brass trim ring



The low profile keypad is only 1" high (25.4 mm) and designed for use with 6120, 6123, and Titan™ PivotBolt™ locks. The battery is kept in an easy-to-access battery compartment near the top of the keypad. The one-battery keypad is designed to protect the lock cable from possible user damage after installation. It is also smaller in diameter (3 3/4" or 95.2 mm) than other S&G® keypads for applications where mounting space is limited.

Part #6130-400 Buffed chrome trim ring



The D-Drive™ rotating keypad is used only with Titan™ D-Drive™ safe locks. The blue button at the top of the keypad indicates that it is for D-Drive™ applications. This small diameter (3 3/4" or 95.2 mm), rotating keypad is only 1" (25.4 mm) high, and will fit most safes, even when mounting space is limited.

Part #6130-200 Buffed chrome trim ring



6130-100—The Spy-Proof® cover makes it difficult for anyone to see which buttons are pressed as a code is entered. It's easily added to any standard two-battery keypad (not for use with one-battery keypads or the Biometric Keypad). It does not interfere with keypad removal for battery replacement. Keypad not included.



6130-600—This Spy-Proof® cover is specially made to work with the D-Drive™ keypad used with S&G Titan™ locks. It does not interfere with battery replacement. Keypad not included.



SARGENT AND GREENLEAF®

A Subsidiary of Stanley Security Solutions, Inc.

Electronic Safe Lock Accessories



SERIAL ADAPTER/CABLE

6350-001—6300 software kit with included data keys and serial interface reader/cable. Windows 95, Windows 98, Windows ME, Windows 2000 and Windows XP-based application for programming the 6300 multiple compartment safe lock and for reading, printing, and archiving audit trail information.



6215-001—Time delay indicator mirrors the time delay period of a 6120 or 6123 lock, and can be remotely located. Displays time delay and opening window. Built-in sounder echoes the time delay beeps emitted by the lock.
6120-060—Cables and junction box needed to hook up the 6215-001.

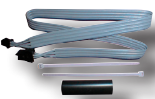

6120-050—20 cm (7.87) long cable extension.
6120-057—60 cm (23.62) long cable extension.
Both kits include wire ties and heat-shrink to provide secure, trouble free connections. Not for D-Drive™ locks.

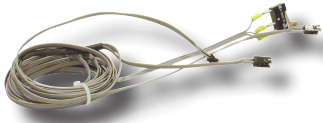

6120-064—Control two locks with a single keypad, based on microswitch activation. Kit includes cable assembly, attached microswitch, heat-shrink, wire ties, and tie blocks.
Not for D-Drive™ models.



7700-021—Magnetic self-stick Safe Light is designed to illuminate the keypad of your electronic lock when there just isn't enough ambient light to see the numbers easily. A quick press of the button gives you two minutes of red light right where you need it. After two minutes, it shuts off automatically to increase battery life. This model extends out from the front of the safe to accommodate electronic lock keypads. Display packaged, one per pack.



7700-020—This Safe Light model is the same as the 7700-021, but does not extend as far from the front of the safe. It's perfect for illuminating the dials of mechanical locks. Display packaged, one per pack.



7700-025—The Safe Light counter display is a self-merchandiser for retailers. The display does NOT include Safe Lights.

Electronic Safe Lock Accessories

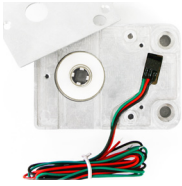

2006-201—Titan™ bolt position indicator (BPI), a special single pole, double throw switch designed to fit into an existing cavity under the Titan's removable front cover. The color-coded leads are already connected. Now your lock can trigger alarms, CCTV recorders, or virtually any relay activated device. Lock not included.



2004-700—Add extra boltwork attachment points to any Titan™ D-Drive™ lock with "wings." Ideal for lightweight safes without bolt control handles. Pushes and pulls 2.5 lbs. (11.12 Newtons). Part number 2004-700 is for a pair of wings.



6102-090—Closes or opens an alarm circuit when the lock's code is entered one number higher on the last code digit. Requires connection to an existing alarm system. Use with a properly configured 6124, 6125, 6126, 6127, Titan™ PivotBolt™, or Titan™ D-Drive™ lock.

6102-100—The same duress feature as the 6102-090 and remote enable. A 5 to 12 VDC input from any source will either enable or disable the lock, depending on how you set the selector switch. The enable/disable portion of the module works with any S&G® electronic safe lock, with the exception of the Model 6300, which has its own built-in enable/disable feature. The duress feature works with any properly configured 6124, 6125, 6126, 6127, Titan™ PivotBolt™, or Titan™ D-Drive™ lock.

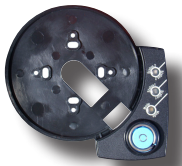

6101-203—The keypad extension base incorporates a port that allows the downloading of audit information from the lock to a Dallas® iButton®. It mounts underneath the keypad. For use with 6126, 6127, 6128, and 6129 locks.

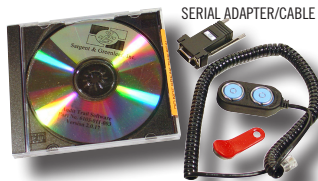

SERIAL ADAPTER/CABLE

SG Audit Software runs on Windows® XP, Windows® 7, Windows® Server 2008, and Windows® Vista operating systems. It includes a cable with a Dallas® key reader and a Dallas® iButton® for transferring the audit information from the lock to your computer. Check your computer to see whether you will need the serial adapter or USB adapter. The appropriate driver software is included with each type of adapter. The keypad extension base and audit trail software kit are both needed to download, view, and manage time and date-stamped audit information captured by a 6126, 6127, 6128, or 6129 lock.



USB ADAPTER/CABLE

6103-130—Audit trail software on CD, serial adapter with cable, and Dallas® iButton®.

6103-131—Audit trail software on CD, USB adapter with cable, and Dallas® iButton®.

6103-102—Key reader with USB adapter with cable only.

6104-006—Extra Dallas® iButton® (red fob).

6102-025—Alarm interface module for 6126, 6127, 6128, and 6129.

6128-500—A-SEAL box with 9-volt battery for 6128 and 6129 locks when a "close seal" code is needed.

A-SEAL BOX

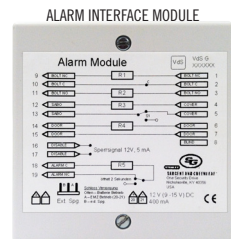

ALARM INTERFACE MODULE

Model 2740 High-Security Electromechanical Safe Lock



MEETS FEDERAL SPECIFICATION FF-L-2740A

for combination locks designed to be mounted on safes, security files, vault doors, and similar items; and intended for the protection of national security information.

- Approved for installation on all classes of GSA-approved security containers.
- Powered by a readily-available, long-life CR123A camera-type battery, with a CR2450 backup battery.
- Built in low battery indicator gives 100 obvious low battery warnings before the backup battery engages.
- Battery life has been tested in excess of 20,000 openings and closings.
- New design motor-driven lock mechanism offers a high level of security by eliminating the threat of vibration and bouncing attacks.
- Penalty Time feature prevents opening by entering sequential or random combinations until a valid combination is found.
- Familiar left-right-left dialing sequence is natural for those users who are already accustomed to using mechanical locks.
- No hard-to-read LCDs or confusing display icons or symbols to interpret.
- Single control and dual control modes.
- Built in relock trigger and thermal relock component for resistance to forced and covert entry attempts.
- Stainless steel lock bolt resists 600 lbs of end and side load.
- Bolt retracts flush with the end of the lock case and travels .461 inch, eliminating the need for an optional short bolt for Mosler retrofits.
- Bolt is drilled and tapped to accept most bolt extensions used in GSA containers.
- Simplified installation makes this the fastest, easiest to install lock in its category. A single brass spindle connects the dial to the lock. No tubes to cut and deburr, and no delicate cables to contend with.
- Uses S&G's "Magic Module" footprint, the standard of the industry, for ease of retrofit.
- Lock cover is retained unless the lock bolt is extended, eliminating the possibility of the safe or vault door being closed while the cover is removed from the lock.

Part Number	Description
2740-100	2740 lock, dial, ring, dust cover, change key (no setup module)
2740-102	2740 lock body and change key only (no dial, ring, or dust cover)
2740-200	2740 setup module with cable and 9-volt battery
2740-103	2740 Spy-Proof dust cover with (2) attaching screws
2740-104	Spy-Proof dust cover retaining screws (package of 12 screws only)
2740-105	2740 change key
2740-106	2740 dial/spindle assembly (maximum 3.875 inch door thickness)
2740-107	2740 stainless steel spline key with attaching screw (package of 5)
2740-108	2740 dial ring with attaching screws



You'll find numerous 2740 resources on the web

2740 Setup Module (product no. 2740-200)

- A setup module is needed to calibrate the lock's dial ring following installation.
- Setup module functions include: battery check, set single control mode, set dual control mode, recover from lost combination, reset lock open latch condition, and dial calibration functions.
- Powered by its own 9-volt alkaline battery.
- Easily plugs into the lock's change key port.



Model 2890 PDL Pedestrian Door Lock

**BUILT TO THE REQUIREMENTS OF
FEDERAL SPECIFICATION FF-L-2890**



- Surface mounted, automatic door deadbolt with pinch-proof strike for protection of SCIFs (Sensitive Compartmented Information Facilities) and other areas where sensitive information and activities need to be protected.
- Incorporates an FF-L-2740A approved S&G model 2740 combination lock for maximum security and ease of operation.
- Accommodates both left-hand and right-hand doors, and is available with four different strikes for in-swing and out-swing doors.
- Inside turn knob allows quick, easy exit from inside the protected area.
- Integral blocking knob (or included key cylinder) can be used to prevent locking of the 2890 PDL when the secure area is occupied.

Part Number	Description
2890-100	2890 PDL lock, dial, ring (no dial ring mounting plate, no strike*)
2890-200	2890 PDL lock, dial, ring, 'N' dial ring mounting plate (no strike*)
2890-201	2890 PDL lock, dial, ring, 'N' dial ring mounting plate, #1 strike
2890-202	2890 PDL lock, dial, ring, 'N' dial ring mounting plate, #2 strike
2890-203	2890 PDL lock, dial, ring, 'N' dial ring mounting plate, #3 strike
2890-204	2890 PDL lock, dial, ring, 'N' dial ring mounting plate, #9 strike
2890-300	2890 PDL lock, dial, ring, 'D' dial ring mounting plate (no strike*)
2890-301	2890 PDL lock, dial, ring, 'D' dial ring mounting plate, #1 strike
2890-302	2890 PDL lock, dial, ring, 'D' dial ring mounting plate, #2 strike
2890-303	2890 PDL lock, dial, ring, 'D' dial ring mounting plate, #3 strike
2890-304	2890 PDL lock, dial, ring, 'D' dial ring mounting plate, #9 strike
2890-400	2890 PDL deadbolt lock (no 2740 lock, dial, ring, dial ring mounting plate, no strike)
2740-300	2740 lock, dial, ring, with special 2890 PDL lock bolt installed (no 2890 PDL, no dial ring mounting plate, no strike)

* Use the illustrations below to select the proper strike for your application and order by the product number under the appropriate illustration.

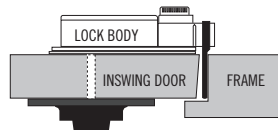

#1 STRIKE
PRODUCT NO. 8497-001

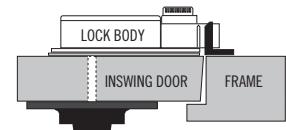

#3 STRIKE
PRODUCT NO. 8497-003

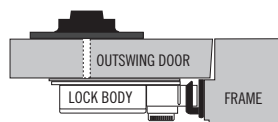

#2 STRIKE
PRODUCT NO. 8497-002

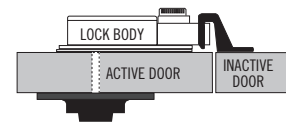

#9 STRIKE
PRODUCT NO. 8497-004



Want to see how it's installed? Here's your link to the installation video.

Mechanical Safe Lock Features Chart

	6730 Series	6731 Series	6741 Series	6630 Series	6631 Series	6651 Series	8410 Series	8430 Series	8550 Series	8560 Series
UL Listed Group 2	✓	✓	✓							
UL Listed Group 2M				✓	✓	✓				
UL Listed Group 1							✓		✓	
UL Listed Group 1R								✓		✓
VdS Class 1	✓		✓			✓				
VdS Class 2		✓							✓	
CEN A	✓		✓			✓				
CEN B		✓							✓	
CNPP A2P			A/E	B	B				B/E	
DNV 3492				✓	✓				✓	
China CCC	✓	✓								
Number of Wheels	3	4	3	3	4	3	3	3	3	3
Theoretical Combinations	1,000,000	100,000,000	1,000,000	1,000,000	100,000,000	1,000,000	1,000,000	1,000,000	1,000,000	1,000,000
Typical Dialing Tolerance*	± 0.5	± 0.5	± 1.0	± 0.5	± 0.5	± 1.0	± 0.5	± 0.5	± 0.5	± 0.5

* Typical dialing tolerance is what you would expect to experience in an installed lock. Theoretical dialing tolerance is always slightly greater (usually about ± 0.4 numbers greater).



Group 2 Mechanical Safe Locks

- 6730 Series: Underwriters Laboratories Listed Group 2, VdS Class 1, CEN A, China CCC.
- The 6730 Series is widely recognized as the standard Group 2 lock of the industry.
- 6731 Series: U.L. Listed Group 2, VdS Class 2, CEN B, China CCC, RoHS compliant.
- Three brass and aluminum wheels provide 1,000,000 theoretical combinations. The four-wheel 6731 model offers 100,000,000 theoretical combinations.
- Made to outperform other locks in the most demanding commercial applications.
- Internal relock trigger secures the lock in the event of a burglar's punch attack.
- 4-way drive cam for mounting right-hand, left-hand, vertical-up, or vertical-down.
- Accepts a wide variety of dials in several attractive finishes (see page 23).
- The 6738 models are switch locks, offering duress and lever position switches, depending on the model ordered.



Lock Bodies (only)

Order Number	No. of Wheels	Notes
6730-010	3	standard lock bolt
6731-004	4	standard bolt

Locks, Dials & Rings

Order Number	No. of Wheels	Notes
6730-100	3	standard bolt, D300/R211 front reading B&W dial and ring
6730-101	3	standard bolt, D003/R004 front reading B&W dial and ring
6730-102	3	standard bolt, D220 Spy-Proof® B&W dial and ring
6730-103	3	standard bolt, D690 front reading, key locking B&W dial and ring
6730-112	3	standard bolt, D225 Spy-Proof®, key locking B&W dial and ring
6731-111	4	standard bolt, D225 Spy-Proof®, key locking B&W dial and ring

- 6741 Series: Underwriters Laboratories Listed Group 2, CEN A, VdS Class 1, CNPP A2P A/E RoHS compliant.
- Three die cast Zamak and aluminum wheels provide 1,000,000 theoretical combinations.
- Die cast push-pull lever with wider dialing tolerances makes the lock easy to dial and less sensitive to bolt side and end pressure than standard levers.
- Designed and constructed to provide a high level of security at a moderate cost.
- Internal relock trigger secures the lock in the event of a burglar's punch attack.
- Four-way drive cam for mounting right-hand, left-hand, vertical-up, or vertical-down.
- Accepts a wide variety of dials in several attractive finishes (see page 23).



Lock Body (only)

Order Number	Number of Wheels	Notes
6741-002	3	standard lock bolt

Lock, Dial and Ring



Order Number	Number of Wheels	Notes
6741-106	3	standard bolt, D300 front reading B&W dial and ring

Group 2M Mechanical Safe Locks

MODEL 6630

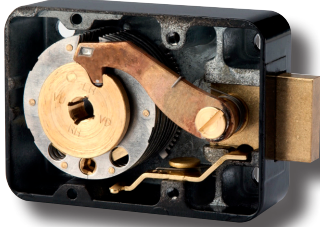

- The 6630 Series is based on the 6730 lock design with added security features such as false wheel gates and an eccentric roller in the lever nose.
- 6630 Series: Underwriters Laboratories Listed Group 2M, A2P B, DNV 3492.
- 6631 Series: Underwriters Laboratories Listed Group 2M, DNV 3492.
- Three brass and aluminum combination wheels provide 1,000,000 theoretical combinations. The four-wheel 6631 Series provides 100,000,000 theoretical combinations.
- Designed and constructed to perform in the most demanding commercial applications.
- Internal relock trigger secures the lock in the event of a burglar's punch attack.
- Four-way drive cam allows mounting right-hand, left-hand, vertical-up, or vertical-down.
- Accepts a wide variety of dials in several attractive finishes (see page 23).

Lock Bodies (only)

Order Number	Number of Wheels	Notes
6630-010	3	standard lock bolt
6631-004	4	standard lock bolt

MODEL 6651

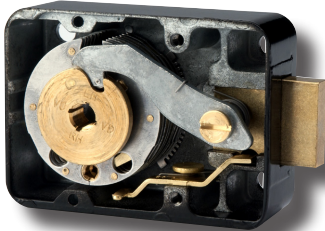

- The 6651 Series is based on the 6630 lock, offering solid security at a reduced cost.
- Underwriters Laboratories Listed Group 2M, VdS Class 1, CEN A.
- False wheel gates and a roller lever provide increased resistance to manipulation.
- Three combination wheels made of Zamak® alloy and aluminum offer 1,000,000 theoretical combinations.
- Internal relock trigger secures the lock in the event of a burglar's punch attack.
- Four-way drive cam allows mounting right-hand, left-hand, vertical-up, or vertical-down.
- Accepts a wide variety of dials in several attractive finishes (see page 23).

Lock Body (only)

Order Number	Number of Wheels	Notes
6651-013	3	standard lock bolt and M6 (metric) mounting screws

Group 2 and 2M locks can be matched with a wide assortment of dials and rings, which may be ordered separately. See page 23.



Dials and Rings for Group 2 and Group 2M Locks



- All dial and rings pictured above and listed in the table directly below can be used with any Group 2 or Group 2M-type lock (pages 21 and 22). They are **NOT** for use with any Group 1 or Group 1R-type lock.
- All dials on this page incorporate a solid, machined brass spindle long enough to accommodate a 3.4 inch (86.5 mm) door thickness. Dials with longer spindles are available as special order items.**
- All dials on this page (with the exception of the D003) incorporate spindles splined to 41 on the dial. This results in a forbidden zone of 90 to 10 in Group 2 and Group 2M combination locks. The D003 spindle is splined to 50, resulting in a forbidden zone of 0 to 20.
- Finishes, spindle lengths, and spindle splining locations other than those listed can be special ordered.**
- Select the correct dial for your Group 2-type or Group 2M-type lock from the chart below.

Dial	Ring	Finish	Description	Use with Lock Models
D003-003	R004-002	B&W	front reading, small knob, spindle splined to 50	6630, 6631, 6651, 6730, 6731, 6738, 6741, 6748
D112-002	R162-002	B&W	Spy-Proof® with a 4-pin tumbler key locking cylinder	6630, 6631, 6651, 6730, 6731, 6738, 6741, 6748
D300-016	R211-002	B&W	front reading, large knob, non-key locking	6630, 6631, 6651, 6730, 6731, 6738, 6741, 6748
D300-021	R211-004	satin chrome	front reading, large knob, non-key locking	6630, 6631, 6651, 6730, 6731, 6738, 6741, 6748
D220-008	R167-002	B&W	Spy-Proof®, large knob, key locking	6630, 6631, 6651, 6730, 6731, 6738, 6741, 6748
D690-007*	R211-002	B&W	front reading, key locking, large knob*	6630, 6631, 6651, 6730, 6731, 6738, 6741, 6748
D690-012*	R211-004	satin chrome	front reading, key locking, large knob*	6630, 6631, 6651, 6730, 6731, 6738, 6741, 6748
D225-008*	R167-002	B&W	Spy-Proof®, key locking, large knob*	6630, 6631, 6651, 6730, 6731, 6738, 6741, 6748
D225-014*	R167-014	satin chrome	Spy-Proof®, key locking, large knob*	6630, 6631, 6651, 6730, 6731, 6738, 6741, 6748

* Dials marked with an asterisk come complete with an additional self-stick escutcheon that does not have a cutout for the key cylinder. It allows you to remove the old escutcheon, remove the key cylinder, and install the new escutcheon to convert the key locking dial to a non-key locking dial.

** Additional terms and charges may apply to special order items.

Group 1 and Group 1R Mechanical Safe Locks



Locks, Dials & Rings

- 8550 Series: Underwriters Laboratories Listed Group 1, VdS Class 2, CEN B, DNV 3492, CNPP A2P B/E.
- 8560 Series: Underwriters Laboratories Listed Group 1R.
- Three wheels (made of brass and aluminum or acetal resin) provide 1,000,000 theoretical combinations.
- Manipulation resistance tested and verified by Underwriters Laboratories to exceed 20 man-hours.
- The 8560 Series has also been tested against 20 man-hours of radiological imaging attacks by Underwriters Laboratories.
- Internal relock trigger secures the lock in the event of a burglar's punch attack.
- Mount right-hand, left-hand, vertical-up, or vertical-down.

Lock Bodies (only)	Order Number	No. of Wheels	Notes
	8550-003	3	U.L. Listed Group 1 (metal wheels)
	8560-004	3	U.L. Listed Group 1R (acetal resin wheels)

Order Number	No. of Wheels	Notes
8550-100	3	U.L. Listed Group 1 lock with D054 Spy-Proof® B&W dial and ring
8560-100	3	U.L. Listed Group 1R lock with D054 Spy-Proof® B&W dial and ring

Dials & Rings (only) for 8500 Series

Dial	Ring	Notes
D054-004	R162-002	B&W Spy-Proof® dial and matching ring (order each separately)
D540-004	R167-002	B&W, Spy-Proof® dial and matching ring (order each separately)
D540-006	R167-014	satin chrome, Spy-Proof® dial and matching ring (order each separately)



Lock Bodies (only)

- The 8400 Series is the direct descendant of the original MP Manipulation Proof® combination lock.
- 8410 and 8415 models are Underwriters Laboratories Listed Group 1. 8430 and 8435 models are Underwriters Laboratories Listed Group 1R.
- Tested and verified by Underwriters Laboratories to resist 20 man-hours of expert manipulation.
- Three combination wheels (made of brass and aluminum or acetal resin) offer 1,000,000 theoretical unique combinations.
- Designed and constructed to perform in the most demanding applications.
- Internal relock trigger secures the lock in the event of a punch attack.
- Using a Centi-Spline dial, the lock can be mounted right-hand, left-hand, vertical-up, or vertical-down.

Order Number	Number of Wheels	Notes
8410-009	3	U.L. Group 1 MP lock
8415-002	3	Group 1 MP with attached tube for insulated safe applications

Locks, Dials & Rings

Order Number	Number of Wheels	Notes
8410-100	3	Group 1 lock with B&W D041 Spy Proof dial and ring
8430-101	3	Group 1R lock with B&W D041 Spy Proof dial and ring

Dial & Ring (only)

Dial	Ring	Notes
D041-010	R162-002	B&W Spy-Proof® Centi-Spline dial and matching ring (order each separately)

Parts for the 8400

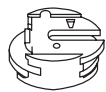

U22 Slider Drive Cam



U14 Inner Spindle
max. door thickness of 3.4" (86 mm)



U18 Spline Key

2937 Model Group 1 Mechanical Safe Lock

**MEETS FEDERAL SPECIFICATION
FF-L-2937**

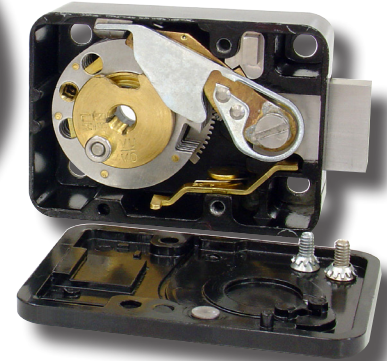

**National Stock Number:
5340-01-566-7405**

- Underwriters Laboratories Listed Group 1.
- Meets Federal Specification FF-L-2937.
- Stainless steel bolt withstands a minimum of 600 lbs. of side and end load.
- Dial spindle incorporates carbide barrier pins and a shear line to control the point of separation in a forced entry attempt.
- Three all metal wheels provide for 1,000,000 unique theoretical combinations.
- Resistance to expert manipulation tested and verified by Underwriters Laboratories to exceed 20 man-hours.
- Built to provide a high level of security for government and defense industry applications.
- Internal relock trigger secures the lock in the event of a burglar's punch attack.
- Integral thermal relock component protects against thermal attacks.
- Two-way drive cam and two-way dial spindle combine to allow mounting right-hand, left-hand, vertical-up, or vertical-down.
- Uses a standard S&G® three wheel change key (U8 or U9).

Locks, Dials & Rings

Order Number	No. of Wheels	Notes
2937-200	3	includes lock, dial* and ring, plus an extra, short, drilled and tapped lock bolt for some Mosler retrofit applications

2937 Individual Components

Order Number	Description
2937-002	Spy-Proof® dial* only
2937-003	dial ring and dust cover only
2937-004	dust cover only

* Dial spindle length will accommodate a maximum door thickness of 3.6 (91.4 mm)



Parts and Accessories for Mechanical Safe Locks

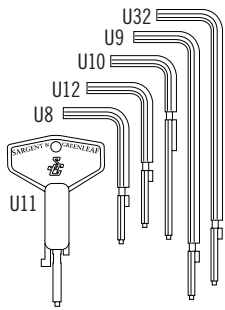

- U32 Long Four Wheel Change Key**—Long handle change key for all standard size locks with four wheels.
- U9 Long Three Wheel Change Key**—Long handle change key for all standard size locks with three wheels.
- U10 Timebination Change Key**—For all Timebination time delay locks with three wheels.
- U12 Standard Four Wheel Change Key**—Regular change key for all standard size locks with four wheels.
- U8 Standard Three Wheel Change Key**—Regular change key for all standard size locks with three wheels.
- U11 Vault Lock Change Key**—Regular change key for all S&G® vault locks with four wheels made after 1956.

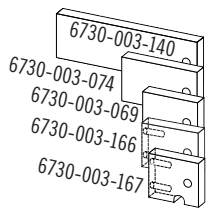

- 6730-003-140 Extra Long Brass Bolt**—Extends 2.461" (62,5 mm) from end of lock case when locked, 2.109" (53,6 mm) from case when unlocked.
- 6730-003-074 Long Brass Bolt**—Extends 0.961" (24,4 mm) from end of lock case when locked, 0.609" (15,5 mm) from case when unlocked.
- 6730-003-069 Standard Brass Bolt**—Extends 0.461" (11,7 mm) from end of lock case when locked, 0.109" (2,8 mm) from case when unlocked.
- 6730-003-166 Metric Tapped Brass Bolt**—Extends 0.461" (11,7 mm) from end of lock case when locked, 0.109" (2,8 mm) from case when unlocked. Bolt is drilled and tapped to a depth of 10 mm for two 4 mm - .7 machine screws.
- 6730-003-167 Short Tapped Brass Bolt**—Extends 0.352" (8,9 mm) from end of lock case when locked. Retracts flush to lock case. Bolt is drilled and tapped to a depth of 3/8" (9,5 mm) for two 10-32 machine screws.



- Spline Keys**—Should be replaced with new whenever removed. Spline keys are solid brass.
- U17 Standard Spline Key**—For 6700 and 8500 series locks.
- U18 Spline Key**—For 8400 series locks only.
- U19 Vault Lock Spline Key**—For 6400 and 6500 series vault locks manufactured after 1956.



- 7600-002 Dial Ring Bearing**—The Delrin® bearing inserts into the back of all S&G® dial rings (except when used with D112 dials) to provide a bearing surface for the dial as it rotates within the ring.
(Delrin® is a registered trademark of Dupont)

Spindle Extension Kits—Used to add spindle length for thick safe or vault doors. Make sure the existing spindle hole is large enough to accommodate the kit's connecting collar. Spindle, extension collar, and spline keys are included in the kit.

- 7312-003**—For standard locks. 5/16"-40 X 6" (152,4 mm) kit with .450" (11.4 mm) diameter collar.
- 7312-005**—For vault locks. 3/8"-30 X 7" (177,8 mm) kit with .510" (13 mm) diameter collar.

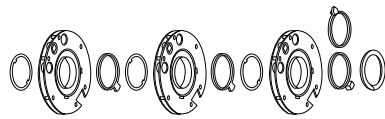

- 9060-001 Wheel Pack**—Brass and aluminum wheel pack for 2937, 6730, 8400, and 8500 series locks. Includes flies and spacer washers. Two top flies are also included, one pointed for use in 8400 locks and a standard top fly for all other locks.



- 7600-005 Key Cylinder**—Disc tumbler cylinder for rekeying or repairing key locking, convertible style dials, or to convert non-key locking dials to the key locking function. Uses a standard Y13 keyway and five brass discs. When the cylinder is pushed into the dial, a spring-loaded brass retainer snaps into position to hold the cylinder in place. Order insert 760-003 separately for conversions. Keyed different only, with two keys per cylinder.



- Dial Inserts**—These metallic, self-stick inserts are used with all large knob, convertible S&G® dials.
- 7600-003**—For all large knob, convertible dials that do incorporate a lock cylinder.
- 7600-004**—For all large knob, convertible dials that do not incorporate a lock cylinder.

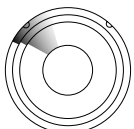

- 6700-001 Dust Cover**—Clear plastic dust cover fits on Spy-Proof® dial rings. Recommended to deter certain types of surreptitious entry techniques. Highly recommended for safes used to store valuable or sensitive information.

Time Locks and Time Movements

- Three-movement time locks offer double-redundancy for dependability and accuracy.
- Two-movement time locks offer single-redundancy to provide built-in movement backup at a reduced cost.
- All movements are precision 13-jewel Swiss mechanisms.
- All time locks on this page are Listed under U.L. Standard 887.
- All models include durable winding charts for easy calculation of winding times.
- A self-adhesive warning label is packed with each time lock to indicate the presence of a time lock on the vault or safe door.

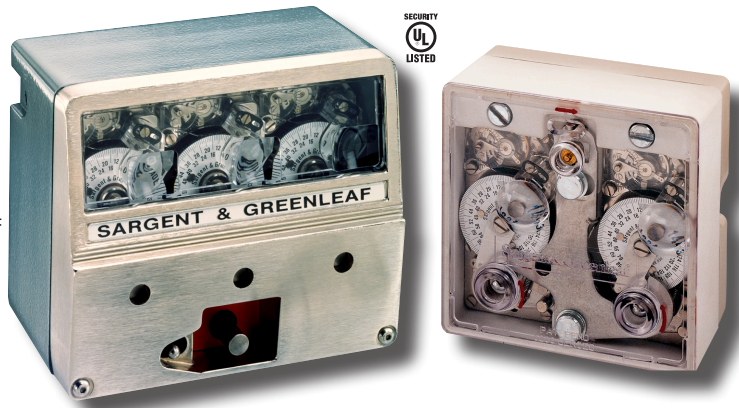

Three-Movement Time Locks

Order Number	Movements	Notes
6370-004	(3) 144 hour standard	standard movements cannot be back-wound if over-set
6370-005	(3) 144 hour reset	reset movements can be back-wound if over-set
6370-006	(3) 144 hour snap-action	snap-action movements can be back-wound if over-set
6370-009	(3) 168 hour reset	reset movements can be back-wound if over-set

Two-Movement Time Locks

Order Number	Movements	Notes
6280-004	(2) 144 hour standard	standard movements cannot be back-wound if over-set
6280-005	(2) 144 hour reset	reset movements can be back-wound if over-set
6280-006	(2) 144 hour snap-action	snap-action movements can be back-wound if over-set



6242-001 Standard Time Lock Movement—Fits three-movement and two-movement time lock cases. The standard movement can be set up to 144 hours. This is a “gradual unlocking” device. It cannot be back-wound if too much time is accidentally wound onto the movement. Precision made, 13-jewel, Swiss mechanism.



6242-002 Reset Time Lock Movement—Fits three-movement and two-movement time lock cases. The reset movement can be set up to 144 hours. This is a “gradual unlocking” device. It can be back-wound if too much time is accidentally wound onto the movement. Precision made, 13-jewel, Swiss mechanism.



6242-003 Snap-Action Time Lock Movement—Fits three-movement and two-movement time lock cases. The snap-action movement can be set up to 144 hours. This is an instant unlocking device, providing extra security against vibration attacks on the vault door. It can be back-wound if too much time is accidentally wound onto the movement. Precision made, 13-jewel, Swiss mechanism.



6242-409-004006 Reset Round Bottom Time Lock Movement—Fits three-movement and two-movement time lock cases. The reset movement can be set up to 168 hours. This is a “gradual unlocking” device. It can be back-wound if too much time is accidentally wound onto the movement. Precision made, 13-jewel, Swiss mechanism. Not recommended for the two-movement time lock case.



6242-004 Filler Block—A filler block should be used in only one position of a three-movement time lock case if only two movements are used. The center position is recommended.

6242-005 Time Lock Winding Key—For winding all S&G® time lock movements.



Mechanical Vault Locks

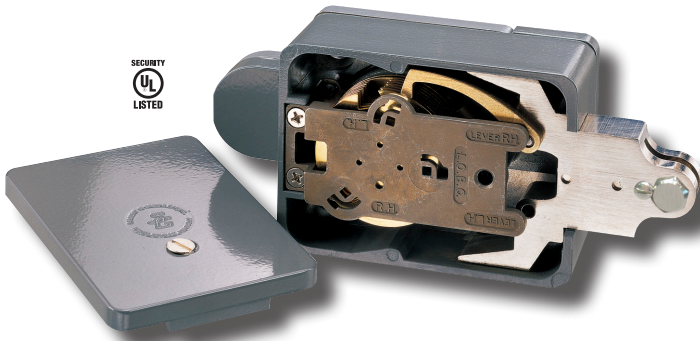

- 6435: Underwriters Laboratories Listed Group 1.
- 6430 and 6530: Underwriters Laboratories Listed Group 2M Recognized Component.
- 6535: Underwriters Laboratories Listed Group 2.
- Extra heavy duty construction for long life and exceptional durability in vault applications.
- Four brass and aluminum combination wheels provide 100,000,000 theoretical combinations.
- Ultra-dependable gravity activated lever allows the lock to be mounted right-hand or left-hand. Not for vertical-up or vertical-down applications.

Vault Lock Bodies (only)

Order Number	Bolt Style	Hand of Lock	U.L. Listing	Drive	Notes
6430-002	square	right-hand only	Group 2M RC	direct	U.L. Group 2M Recognized Component
6430-003	square	left-hand only	Group 2M RC	direct	U.L. Group 2M Recognized Component
6430-004	center extension	right-hand only	Group 2M RC	direct	U.L. Group 2M Recognized Component
6430-005	center extension	left-hand only	Group 2M RC	direct	U.L. Group 2M Recognized Component
6435-003	square	right-hand only	Group 1	indirect	can be field configured for center, upper, or lower drive
6435-004	square	left-hand only	Group 1	indirect	can be field configured for center, upper, or lower drive
6435-005	center extension	right-hand only	Group 1	indirect	can be field configured for center, upper, or lower drive
6435-006	center extension	left-hand only	Group 1	indirect	can be field configured for center, upper, or lower drive
6435-008	roller	left-hand only	Group 1	indirect	can be field configured for center, upper, or lower drive
6435-009	upper extension	right-hand only	Group 1	indirect	can be field configured for center, upper, or lower drive
6530-001	center extension	reversible	Group 2	direct	field configurable for left-hand or right-hand mounting
6530-002	roller	reversible	Group 2	direct	field configurable for left-hand or right-hand mounting
6530-003	square	reversible	Group 2	direct	field configurable for left-hand or right-hand mounting
6535-002	roller	reversible	Group 2	indirect	field changeable for handing and type of indirect drive
6535-005	upper extension	reversible	Group 2	indirect	field changeable for handing and type of indirect drive
6535-007	center extension	reversible	Group 2	indirect	field changeable for handing and type of indirect drive
6535-010	square	reversible	Group 2	indirect	field changeable for handing and type of indirect drive



Vault Locks Dials & Rings

Dial	Ring	Notes
D240-003	R167-002	Spy-Proof®, B&W, key locking, for maximum 6.5" (165,1 mm) door thickness
D240-007	R167-014	Spy-Proof®, satin chrome, key locking, for maximum 6.5" (165,1 mm) door thickness

Drive Configurations—In a direct drive vault lock the dial spindle enters the lock case directly. In an indirect drive vault lock the dial spindle attaches to a drive gear located outside the lock case, so that the dial is not directly in line with the lock case, but above, below, or to one side of the case. The drawings below (right) illustrate the three indirect drive configurations.

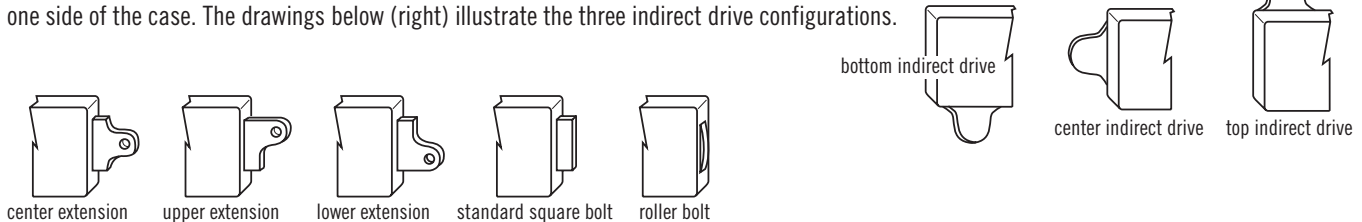

Bolt Variations—Vault locks can be equipped with one of five different bolts. The three extension models are designed to attach directly to boltwork or a blocking bar. The standard square bolt is used to block moving boltwork. The roller bolt, seldom used today, opens to provide a path into the lock case into which a boltwork extension can move. The five bolt configurations are illustrated above (left).

Key-Op® Key Operated Safe Lock



6804-008 Guide Tube—Fits into a matching recess in the front of the lock case, and extends to the back of the key hole escutcheon. It is meant to guide the key into the lock, and is suitable for thick doors and insulated doors. Tube length is 1 meter, and can easily be cut to length.

6804-033 Buffed chrome hinged cover keyhole escutcheon



6804-009 Satin nickel finish self-stick keyhole escutcheon

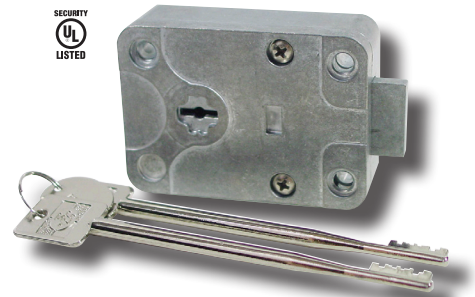

- Underwriters Laboratories Listed under Standard 437 as a Security Container Lock.
- Available in single and double bitted key versions.
- Same mounting footprint as S&G® standard size combination locks, with the key hole in the same place as the spindle hole. Key hole through the safe door must be at least 9/16" (14,3 mm) in diameter.
- Keys are nickel plated brass for durability and long life.

Key-Op Locks with Keys

Order Number	Key Retention	Key Style	Notes
6804-049	key retaining	single bitted	includes (2) keys and (1) 6804-009 escutcheon
6824-005	key retaining	double bitted	includes (2) keys and (1) 6804-009 escutcheon
6805-005	non-key retaining	single bitted	includes (2) keys and (1) 6804-009 escutcheon

Key-Op Key Blanks and Pre-Cut Keys

Order Number	Description	Keys per Package	Notes
6804-019	uncut key blank	1	single bit, for 3" (76,2 mm) max. door thickness
6804-017	pre-cut keys	2	single bit, for 3" (76,2 mm) max. door thickness
6804-018	pre-cut keys	3	single bit, for 3" (76,2 mm) max. door thickness
6824-017	uncut key blank	25	double bit, for 3" (76,2 mm) max. door thickness
6824-016	pre-cut keys	2	double bit, for 3" (76,2 mm) max. door thickness

Safe Handle

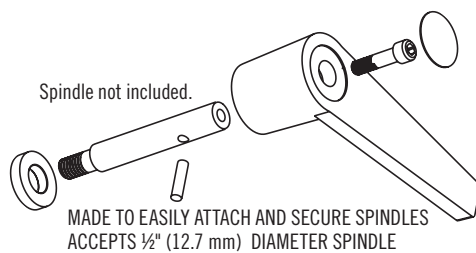

2629-010

S&G® Satin Chrome Safe Handle

Order Number	Finish	Notes
2629-010	satin chrome	1/2" (12,7 mm) pilot hole for handle shaft

6870 Series Key Operated Safe Lock



- Underwriters Laboratories Listed under Standard 437 as a Security Container Lock.
- Same mounting footprint as S&G® standard size combination locks, with the key hole in the same place as the spindle hole. Key hole through the safe door must be at least 1/2" (12,7 mm) in diameter, or a minimum of 5/8" (15,9 mm) if a guide tube is used.
- True double-bitted lock with nine opposing brass levers and a mechanism that permits changing to new keys in seconds, with no special tools.

6870 Locks with Keys

Order Number	Keys Included	Notes
6870-016	3	keys are for a maximum door thickness of 2.26" (57,4 mm)
6870-008	2	keys are for a maximum door thickness of 4.22" (107,1 mm)
6870-028	4	keys are for a maximum door thickness of 4.22" (107,1 mm)

6870 Pre-Cut Key Sets

Two Key Set	Three Key Set	Four Key Set	Notes
6870-112	6870-113	6870-114	pre-cut keys for 2.26" (57,4 mm) max door thickness
6870-132	6870-133	6870-134	pre-cut keys for 4.22" (107,1 mm) max door thickness
6870-202	6870-203	6870-204	pre-cut bit sets for use with 6870-200 stem

Detachable Bits

Order Number	Notes
6870-200	key stem only for detachable bit for 7.57" (192,3 mm) maximum door thickness
6870-201	uncut detachable bit for use with key stem listed above

Key Blanks

Order Number	Notes
6870-110	for 2.26" (57,4 mm) max door thickness
6870-130	for 4.22" (107,1 mm) max door thickness



6870-370 Guide Tube—Guides the key into the lock, and is suitable for thick doors and insulated doors. Tube length is 1 meter, and can easily be cut to length. The tube is an option and is not included with locks. It requires a 5/8 inch (0.625" or 15,9 mm) hole through the safe door and an escutcheon.



4200 and 4400 Series Safe Deposit Locks

- All locks on this page are Listed by Underwriters Laboratories under Standard 437.
- The 4200 and 4400 family of safe deposit locks represent an industry standard trusted by financial institutions worldwide for over 80 years.
- Factory matchwork is available upon request to match many manufacturers' guard keys, provided a sample of the guard key is made available to us.
- The pick resistant lever design also resists advanced decoding techniques.
- S&G® safe deposit locks are all key retaining for added security in daily operations.
- Two renter keys are provided with each lock. Renter sides are keyed different. Guard keys are not provided.
- All locks on this page have brass plated covers and plugs.
- The 4444 lock is designed as the primary lock for B and C-rate depository safes and for inner compartment doors. It incorporates special burglary resistant features. Its bolt is drilled and tapped for an 8-32 machine screw to accommodate boltwork attachment.

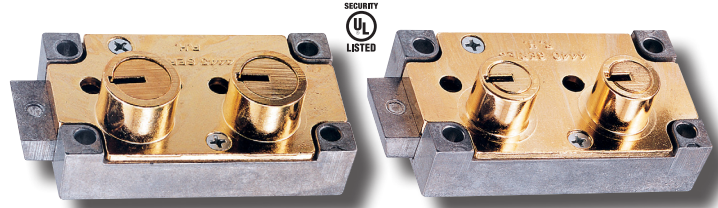

4200 Series

Order Number	Lock Style	Renter Nose Diameter	Guard Nose Diameter	Hand of Lock	Nose Height	Guard Setting
4231-002	4231	.672" (17 mm)	.672" (17 mm)	left-hand	0.5" (12.7 mm)	SY3
4231-008	4231	.672" (17 mm)	.672" (17 mm)	right-hand	0.5" (12.7 mm)	SY3
4420-010	4420	.672" (17 mm)	.672" (17 mm)	left-hand	0.5" (12.7 mm)	#4
4420-042	4420	.672" (17 mm)	.672" (17 mm)	right-hand	0.5" (12.7 mm)	#4

4400 Series

Order Number	Lock Style	Renter Nose Diameter	Guard Nose Diameter	Hand of Lock	Nose Height	Guard Setting
4440-018	4440	.672" (17 mm)	.672" (17 mm)	left-hand	0.5" (12,7 mm)	#4
4440-070	4440	.672" (17 mm)	.672" (17 mm)	right-hand	0.5" (12,7 mm)	#4
4442-004	4442	.840" (21,3 mm)	.672" (17 mm)	left-hand	0.5" (12,7 mm)	#4
4442-014	4442	.840" (21,3 mm)	.672" (17 mm)	right-hand	0.5" (12,7 mm)	#4
4443-008	4443	.840" (21,3 mm)	.840" (21,3 mm)	left-hand	0.5" (12,7 mm)	#4
4443-028	4443	.840" (21,3 mm)	.840" (21,3 mm)	right-hand	0.5" (12,7 mm)	#4
4444-002	4444	.672" (17 mm)	.672" (17 mm)	right-hand only	0.5" (12,7 mm)	#4

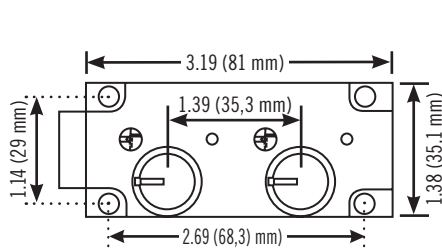

4420—designed for matchwork to all Corbin guard keys (RH model shown here)

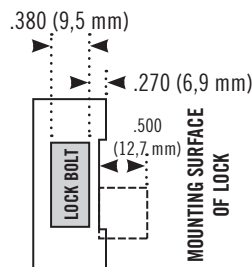

All locks on this page (with the exception of the 4444) have an extended bolt length of .40" (10,2 mm), with a bolt throw of .31" (7,9 mm).

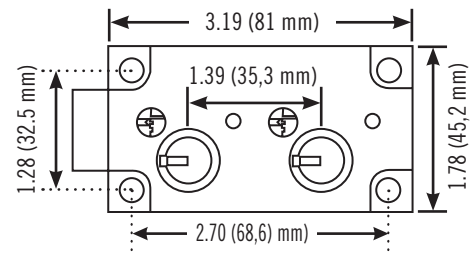

4440—a standard of the safe deposit industry since 1922

These dimensions also apply to:

- 4231—designed for matchwork to the Yale SY3 guard key
- 4442—designed for matchwork to the Diebold 175 series
- 4443—designed for matchwork to the Mosler 5700 series

4500 Series Safe Deposit Locks

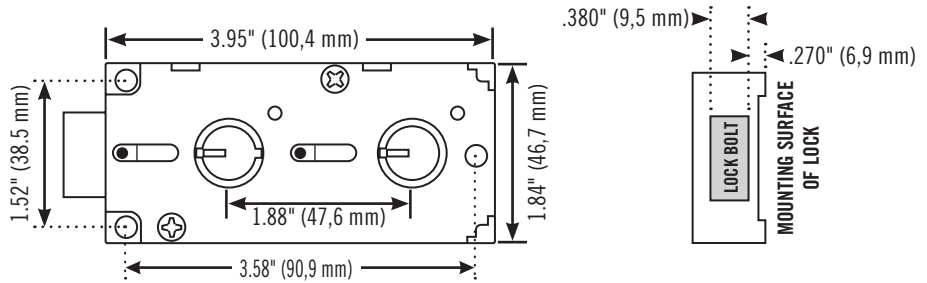
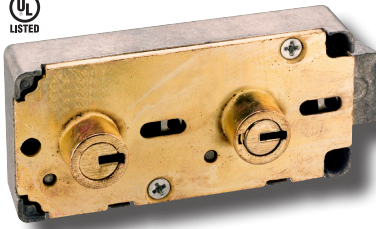

- The centerline design of the 4500 Series allows the same lock to be mounted either left-hand or right-hand.
- Factory matchwork is available on request to match many manufacturers' guard keys. A sample guard key must be provided.
- The 4500 Series is Listed by Underwriters Laboratories under Standard 437.

4500 Series

Order Number	Lock Style	Renter Nose Diameter and Lever Type	Guard Nose Diameter and Lever Type	Nose Height
4544-020	centerline	.672" (17 mm) — changeable	.672" (17 mm) — changeable	3/8" (9.5 mm)
4545-004	centerline	.672" (17 mm) — changeable	.672" (17 mm) — changeable	1/2" (12.7 mm)

4100 Series Cabinet Locks

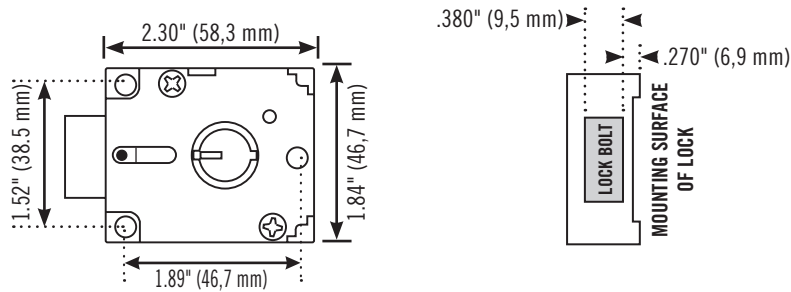

- The 4100 Series is a collection of single nose changeable key cabinet locks.
- Four nose heights to accommodate different door thicknesses.
- Attractive brass plated cover and plug.
- Supplied with two matching keys.
- Can be mounted right-hand or left-hand.

4100 Series

Order Number	Lock Style	Nose Height	Nose Diameter and Lever Type
4110-003	4100	1/8" (3,2 mm)	.672" (17 mm) — changeable
4111-003	4100	1/4" (6,4 mm)	.672" (17 mm) — changeable
4112-003	4100	3/8" (9,5 mm)	.672" (17 mm) — changeable
4113-003	4100	1/2" (12,7 mm)	.672" (17 mm) — changeable

Safe Deposit and Cabinet Lock Key Blanks

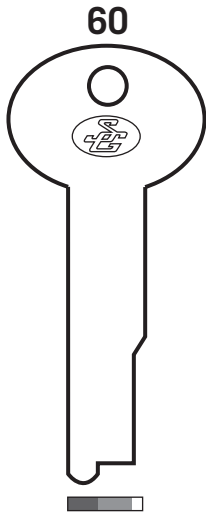

60
 .070" (1,78 mm)
 .390" (9,91 mm)
 .315" (8,9 mm)

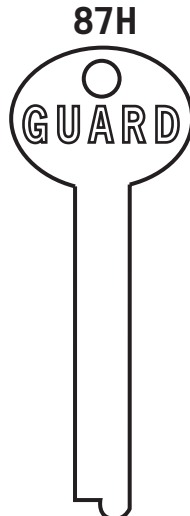

87H
 .080" (2,03 mm)
 .275" (6,99 mm)

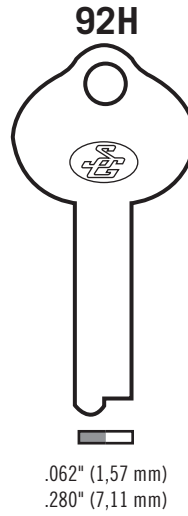

92H
 .062" (1,57 mm)
 .280" (7,11 mm)

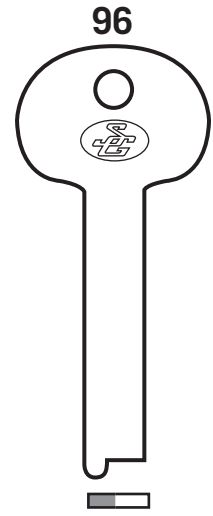

96
 .070" (1,78 mm)
 .315" (8,0 mm)

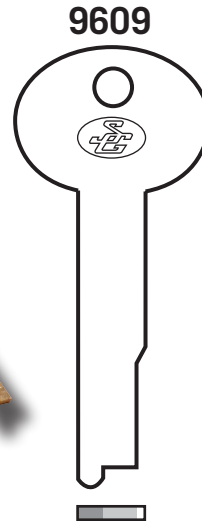
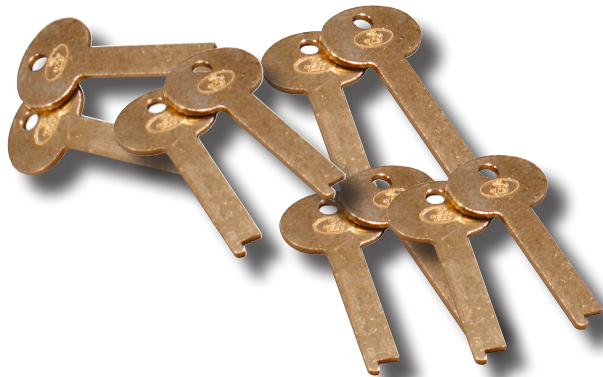

9609
 .070" (1,78 mm)
 .350" (8,89 mm)

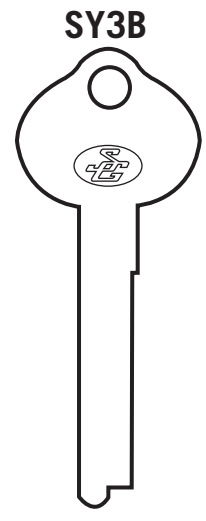

SY3B
 .063" (1,6 mm)
 .243" (6,17 mm)

- All key blanks on this page are made of nickel-silver for long life and smooth operation.
- Silhouettes are slightly larger than actual size to allow you to lay a key on the drawing and see part of the line thickness around the edges. Tolerances are $\pm .003$ " (0,076 mm) from listed dimensions. Cross sections are viewed as if looking from the bow of the key toward the tip, or as if looking at the keyway broaching. Shading indicates tip projection and any other blade width variations.

Safe Deposit and Cabinet Lock Key Blanks

Order Number	Designation	Notes
9500-005	60	used for renter key with 4442 and 4443 Series safe deposit locks
9500-001	87H	standard guard key blank for 4420, 4440, 4442, 4444, and 4500 Series safe deposit locks
9500-016	92H	used for R132 Series key locking dial ring
9500-003	96	standard renter key blank for 4231, 4420, 4440, 4444, 4100, and 4500 Series locks
9500-004	9609	used for the guard key with 4443 Series safe deposit locks
9500-002	SY3B	used for the guard key for the 4231 Series safe deposit lock (Yale matchwork)

8077AD Combination Padlock



National Stock Numbers:

5340 00 285 6523 (GSA)

5340 01 196 2568 (DLA)

5340 01 217 2009

All refer to the 8077AD padlock with hardened steel shackle.

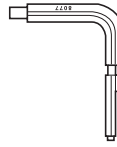

8077-043 Padlock Change Key—Replacement change key for all 8077 padlocks. Comes with changing instructions.



Dimensions and Specifications

shackle material: case hardened steel
 shackle diameter: 5/16 (8 mm)
 clear shackle opening when locked: 7/8 (22 mm)
 overall dimensions: 4 5/32 (10,6 cm) high
 2 3/8 (6,0 cm) wide
 1 31/32 (5,0 cm) deep
 weight: 1.75 lbs. (0,8 kilograms)

- Built to conform to stringent government specifications, including 30 minute protection against expert manipulation and 10 minute protection against surreptitious entry attack.
- Field changeable combination with the use of a change key.
- 125,000 possible combinations.
- Packaged with change key and complete operating/changing instructions.

8077AD Padlock

Order Number	Dial	Shackle Material	Recommended Hasp Opening for Shackle
8077-108	black	case hardened steel	3/8" (9,5 mm)

951C High Security Padlock



Dimensions and Specifications

shackle material: hardened steel
 shackle diameter: 1/2 (12,7 mm)
 throat opening in shackle shroud: 3/4 (19 mm) wide
 7/16 (11,1) high
 clear shackle opening when locked: 5/8 (15,8 mm)
 overall dimensions: 4 11/16 (11,9 cm) high
 2 3/4 (7,0 cm) wide
 1 13/16 (4,4 cm) deep
 weight: 4 lbs. (1,81 kilograms)

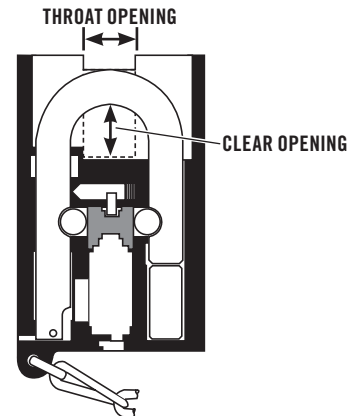

This is the commercial keyway (S1) version of the Model 951 padlock. Verify that it meets applicable security requirements before ordering.

- This rugged, key retaining padlock is built to conform to rigid specifications for indoor and outdoor high security applications—Ideal for perimeter security and any location requiring a high degree of resistance to forced entry.
- Easily field disassembled by use of a control key for service or rekeying.
- Equipped with a commercially available, high security Medeco® key cylinder.
- Cast stainless steel body.
- Body and shackle incorporate exotic barrier materials for maximum resistance against cutting, drilling, and sawing.
- Shrouded shackle offers 5/8" (15,8 mm) clear opening and provides a high degree of resistance against common wedging attacks.

951 Padlock

Order Number	Keying Information	Keys	Notes
951-009	keyed different	1 control key 2 operator keys	includes attached chain and clevis

Extension 50 Mechanical Automatic Door Deadbolt

- Surface mounted for ease of installation and suitability for a wide range of applications.
- Automatic locking deadbolt mechanism incorporates an inside release knob for rapid egress, and a manual “dogging” switch to keep the device unlocked when the secured area is occupied.
- Strikes available for both inswing and outswing doors.
- Equipped with either an 8400 or 8500 Series Group 1 or Group 1R combination lock for a high level of security.
- An ideal security solution for indoor applications, such as ATM rooms, cash handling areas, research laboratories, etc.
- All units include a rectangular hardplate that is placed under the mounting plate to deter forced entry attacks.
- Interlocking strike (any model) prevents spreading of the door and frame.
- Hardened steel pins inside the locking bolt deter sawing and increase forced entry resistance.

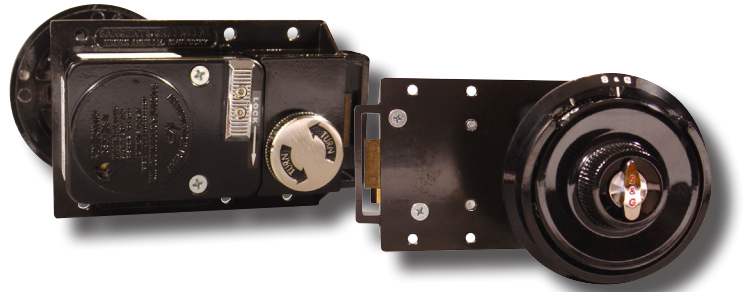

Extension 50

Order Number	Lock Model	Lock Wheels	Dial and Ring	Strike
8415-107	8400 Group 1	aluminum & brass	included—D041/R162 B&W	not included—order separately
8435-106	8400 Group 1R	acetal resin & brass	included—D041/R162 B&W	not included—order separately
8555-105	8500 Group 1	aluminum & brass	included—D054/R162 B&W	not included—order separately
8565-105	8500 Group 1R	acetal resin & brass	included—D054/R162 B&W	not included—order separately

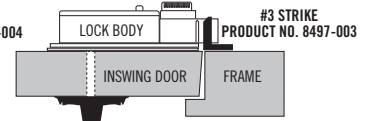
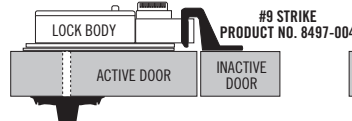
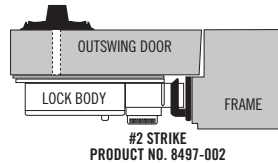
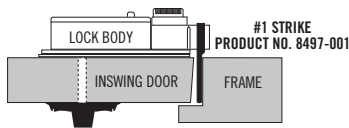

Sliding Mechanical Deadbolts

- Full 1" (25,4 mm) bolt throw.
- Both models can be secured in the locked or unlocked position.
- Hardened steel bolt pins resist sawing and over one ton of thrust.
- Surface mount design for ease of installation and suitability to a wide range of applications.
- The 1881 model will accept any 5/16" (8 mm) diameter shackle padlock, such as the S&G® 8077AD.
- The 1883 model incorporates a 4-pin tumbler cylinder operated by keys cut on National D4291 blanks.

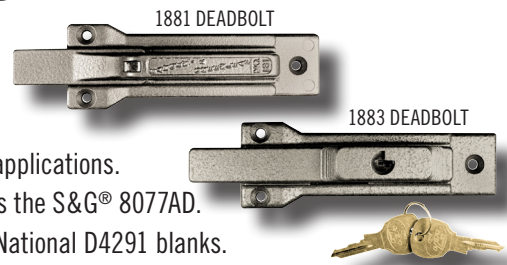

1881 and 1883 Deadbolts

Non-Key Locking (requires padlock)	Integral 4-Pin Key Cylinder	Included Strike
1881-001	1883-001	none
1881-002	1883-002	#12
1881-003	1883-003	#13
1881-004	1883-004	#14
1881-005	1883-005	#15

National Stock Number 5340-01-210-5589 can apply to any 1881 deadbolt. When using this National Stock Number, specify which strike is to be included, or specify that no strike is needed.



SARGENT AND GREENLEAF®

A Subsidiary of Stanley Security Solutions, Inc.

The Brute® Electronic Door Deadlatch

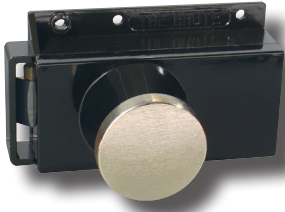

National Stock Numbers 5340-01-020-5681 and 6350-00-610-1962 can refer to any model of The Brute® deadlatch. You must specify inswing or outswing and strike number. This is the only way to ensure you receive hardware suited to your application.

Electrical Specifications:

Required voltage: 24 VDC

DC coil resistance: 6 OHMS

Current: 5.5 to 6.5 AMPS

Minimum recommended wire size: 18 gauge

- Surface mounted for ease of installation and suitability for a wide range of applications.
- Inside release knob provides for rapid egress.
- Strikes available for both inswing and outswing doors.
- An ideal security solution for indoor applications, such as ATM rooms, cash handling areas, research laboratories, etc.
- Originally designed to be used with the (discontinued) S&G® Code/Tronic™ III access control device, The Brute® deadlatch can be used with any control device that meets its electrical requirements.
- The Brute® deadlatch uses a heavy duty 12 VDC solenoid. The 24 VDC voltage requirement increases bolt retraction force and will not harm the solenoid.

The Brute

Order Number	Application	Included Strike(s)
8497-100	inswing door	#1 for inswing doors
8497-101	outswing door	#2 for outswing doors
8497-102	inswing door	#3 for inswing doors
8497-103	outswing door	#9 for outswing double doors
8497-105	inswing door	none
8497-106	outswing door	none

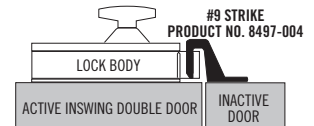
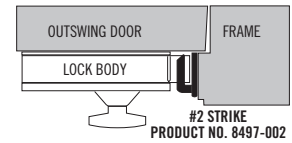
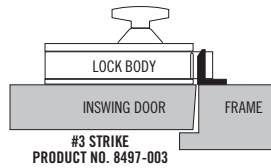
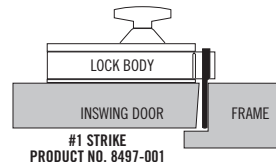

Product Compliance and Certifications

Sargent & Greenleaf sells its products in some 140 countries. Different countries and regions create and adhere to their own specifications for safes and locks. Because S&G does business in virtually all corners of the globe, our products are often submitted to various international testing agencies to verify that they meet particular specifications for the market(s) into which they are being sold. This is why you will see some or all of these symbols on various product pages throughout this catalog.



The European Union has set forth guidelines to curb the use of substances which have been determined to be detrimental to the environment. Individual member countries create their own regulations based on the RoHS guidelines published by the European Union.

When you see the RoHS (Reduction of Hazardous Substances) symbol next to a product in this catalog, it means this product has been certified acceptable under the RoHS guidelines. For specific product information as it relates to this issue, go to this page on our website: www.sargentandgreenleaf.com/rohs.php



ARM-A-DOR® Secure Panic Exit Hardware



ONE YEAR PARTS REPLACEMENT WARRANTY ON ALARM COMPONENTS AND FIVE YEAR DEFECTIVE PARTS REPLACEMENT WARRANTY ON ALL OTHER MECHANICAL COMPONENTS

- Conforms to these requirements: U.L. 305 Panic Device Rating, U.L. 10B Fire Exit Hardware, 3 hrs at 2000, Dade County (Florida) Product Control Approved No. 07-1219.12 (Hurricane), NFPA 101 Life Safety Code, UBC/ BOCA, ANSI 156.3, City of New York Department of Buildings, MEA 292-96-E.
- Arm-A-Dor® secure panic hardware offers 24-hour protection, keeping intruders out while providing life-saving security within. Developed for retail back door security by retail industry construction experts, Arm-A-Dor® has many commercial, industrial and institutional applications.
- Surface mounted for ease of installation and suitability for a wide range of applications.
- Select a model that automatically locks whenever the door is closed, or one that must be manually locked, whichever suits your particular application.
- Offers locking bar protection for security from the outside, single motion egress, and Life Safety compliance.
- Designed as a security system for service and emergency exits, the Arm-A-Dor® device is for exit-only doors and cannot be configured to unlock from the outside.
- All models are US28 finish, exit-only, and can be mounted either left-hand or right-hand.

Arm-A-Dor® Secure Panic Exit Hardware

Order Number	Description	Door Size	Alarm	Fits Jambes	Notes
A101-001	automatic relock	3' to 4'	no	up to 6 3/4"	
A101-002*	automatic relock	3' to 4'	yes	up to 6 3/4"	(2) 9 volt batteries included
A102-001	manual relock	3' to 4'	no	up to 6 3/4"	
A102-002*	manual relock	3' to 4'	yes	up to 6 3/4"	(2) 9 volt batteries included
A101-F01	automatic relock, fire rated	3' to 4'	no	up to 6 3/4"	fire rated
A101-F02*	automatic relock, fire rated	3' to 4'	yes	up to 6 3/4"	(2) 9 volt batteries included
A101-012	automatic relock, pre-assembled	3' only	no	5 1/4" to 5 3/4"	
A101-013*	automatic relock, pre-assembled	3' only	yes	5 1/4" to 5 3/4"	(2) 9 volt batteries included
A101-014	automatic relock, pre-assembled	4' only	no	5 1/4" to 5 3/4"	
A101-015*	automatic relock, pre-assembled	4' only	yes	5 1/4" to 5 3/4"	(2) 9 volt batteries included

* Alarm units require a standard 1 1/8" mortise cylinder to allow the alarm control to be keyed into existing systems. For this reason, the mortise cylinder is not supplied with the exit device, and is not available from S&G.

- A103-002—RX (request for exit) Switch Kit for wiring into an existing system.
- A103-003—Alarm sub-assembly to convert a non-alarmed unit to one with an alarm.
- A104-001—Low Profile Installation Kit for installations where door jambes are deeper than 6 3/4".
- A106-001—Standard Double Door Kit fits all models of Arm-A-Dor®.
- A106-002—Low Profile Double Door Kit for installations where door jambes are deeper than 6 3/4".
- A107-001—AC Adapter Kit for plug-in battery backup.
- A107-002—AC Adapter Hardwire Kit for wiring the alarm into your electrical system with battery backup.
- 1881-003—Sliding deadbolt assembly with strike and integral padlock hasp for double door installations (see page 35).
- 1883-003—Sliding deadbolt assembly with strike and integral key lock for double door installations (see page 35).

DIMENSIONS—6120 AND 6123 SERIES CASE

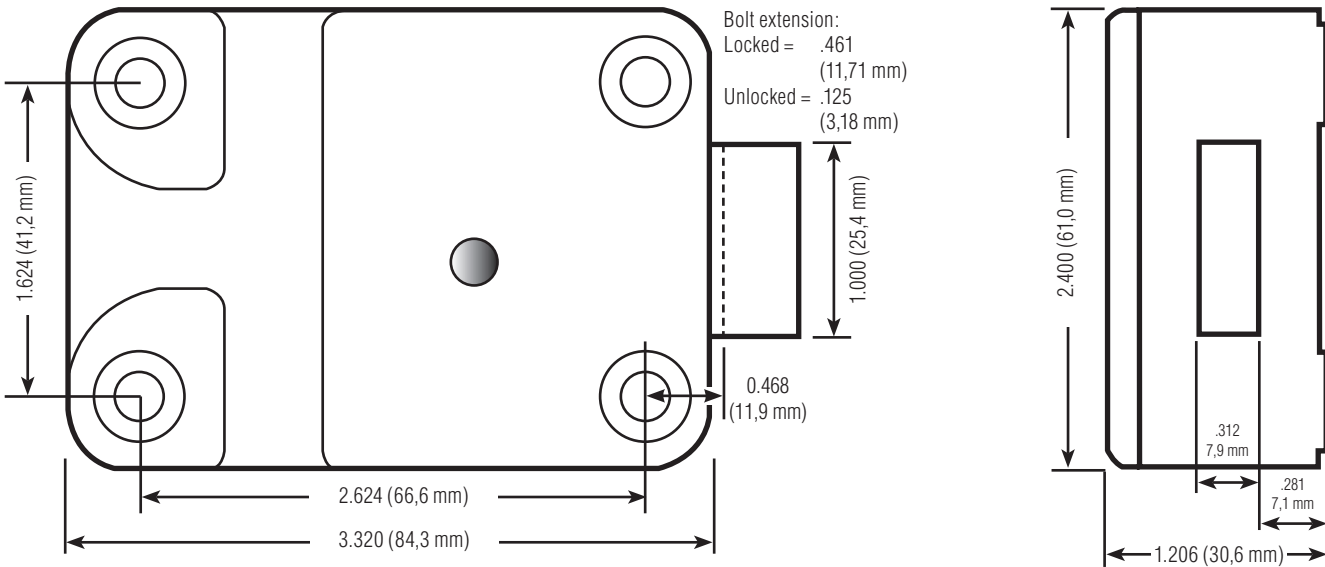

CAUTION: SAFE BOLTWORK SHOULD NEVER MOVE CLOSER THAN .150 INCH (3.8 MM) TO THE BOLT END OF THE LOCK CASE.

DIMENSIONS—6124, 6126, 6128, 6300 SERIES CASE

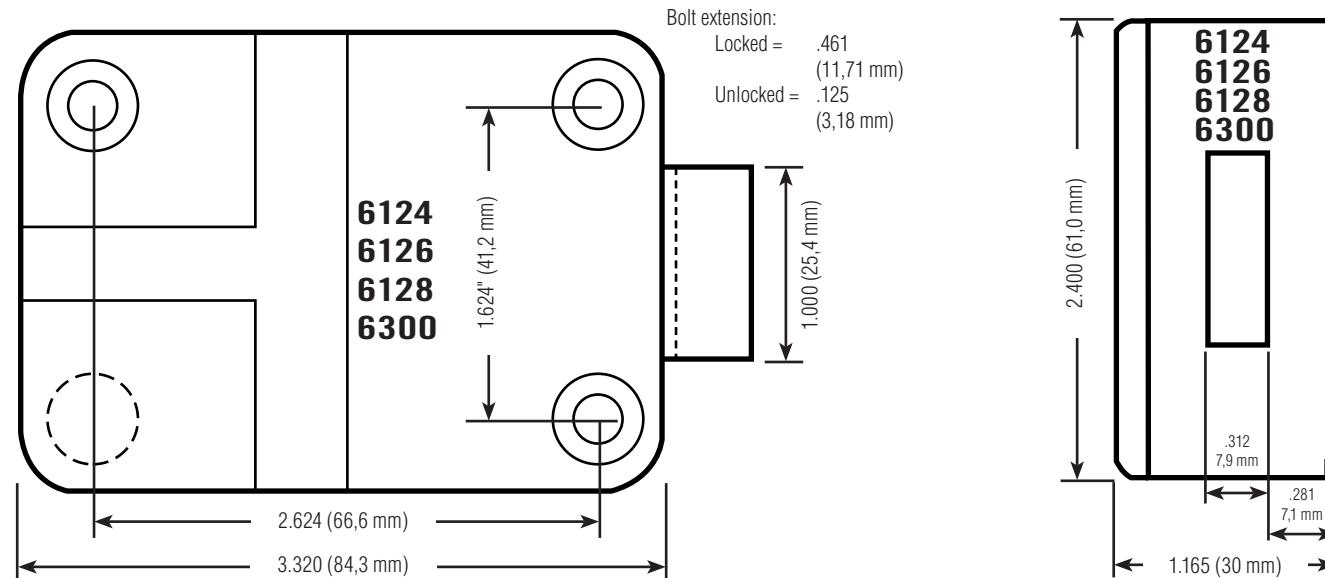

CAUTION: SAFE BOLTWORK SHOULD NEVER MOVE CLOSER THAN .150 INCH (3.8 MM) TO THE BOLT END OF THE LOCK CASE.

DIMENSIONS— 6125, 6127, 6129 SERIES CASE

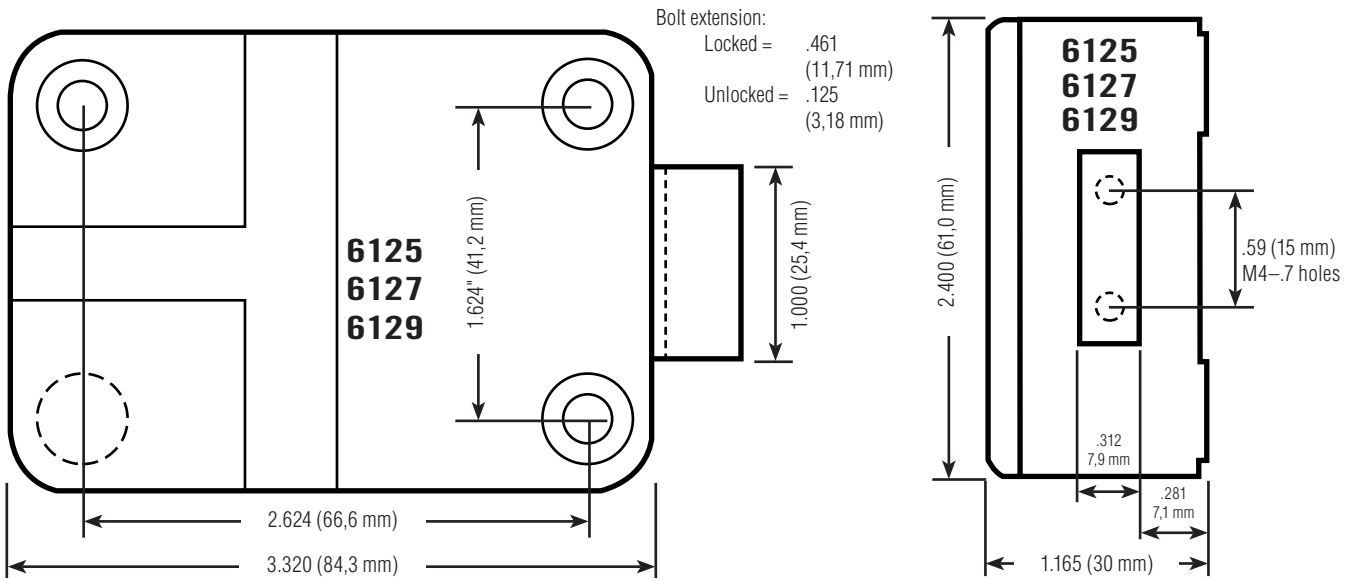

Specifications for the user-supplied switch needed to signal models 6125, 6127, and 6129 that safe boltwork is extended and it is okay to extend the lock bolt:

Minimum voltage rating: 30 VDC

Minimum current rating: 50 milliamperes

Electrical contact material: silver

Switch operation: snap acting contacts

Contact configuration: lock bolt extends on contact closure

Switch actuator: recommend lever or roller actuator, depending on boltwork design

Switch operating life: minimum of 50,000 cycles

Switch connectors: recommend .110" (2.8 mm) X .020" (.5 mm) quick connect tabs

The bolt throw of the 6125, 6127, and 6129 can be adjusted. If your application requires more than .46" (11,7 mm) bolt travel, remove the bolt travel adjustment screw and add a .075" (2 mm) thick spacer when attaching safe boltwork to the lock bolt.

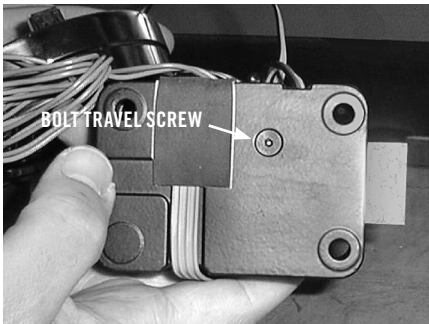

Standard bolt extension:

Locked = 0.461 (11,71 mm)

Unlocked = 0 (flush with case)

Throw = 0.461 (11,71 mm)

Travel screw removed:

Locked = 0.461 (11,71 mm)

Unlocked = -0.08 (-2 mm) (recessed)

Throw = 0.54 (13,71 mm)

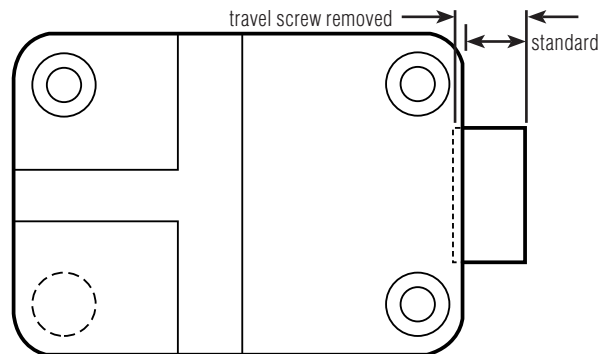

DIMENSIONS—TITAN™ PIVOTBOLT™ CASE

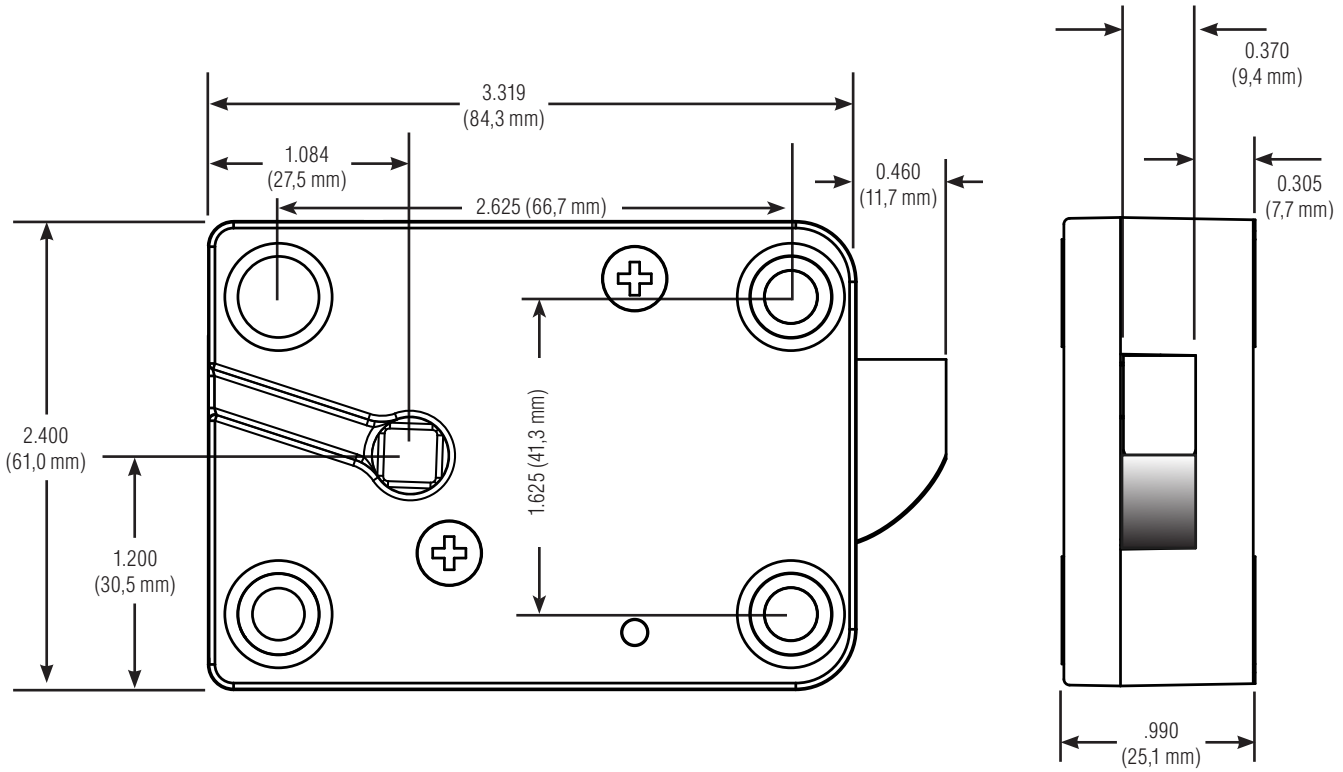

DIMENSIONS—TITAN™ D-DRIVE™ CASE

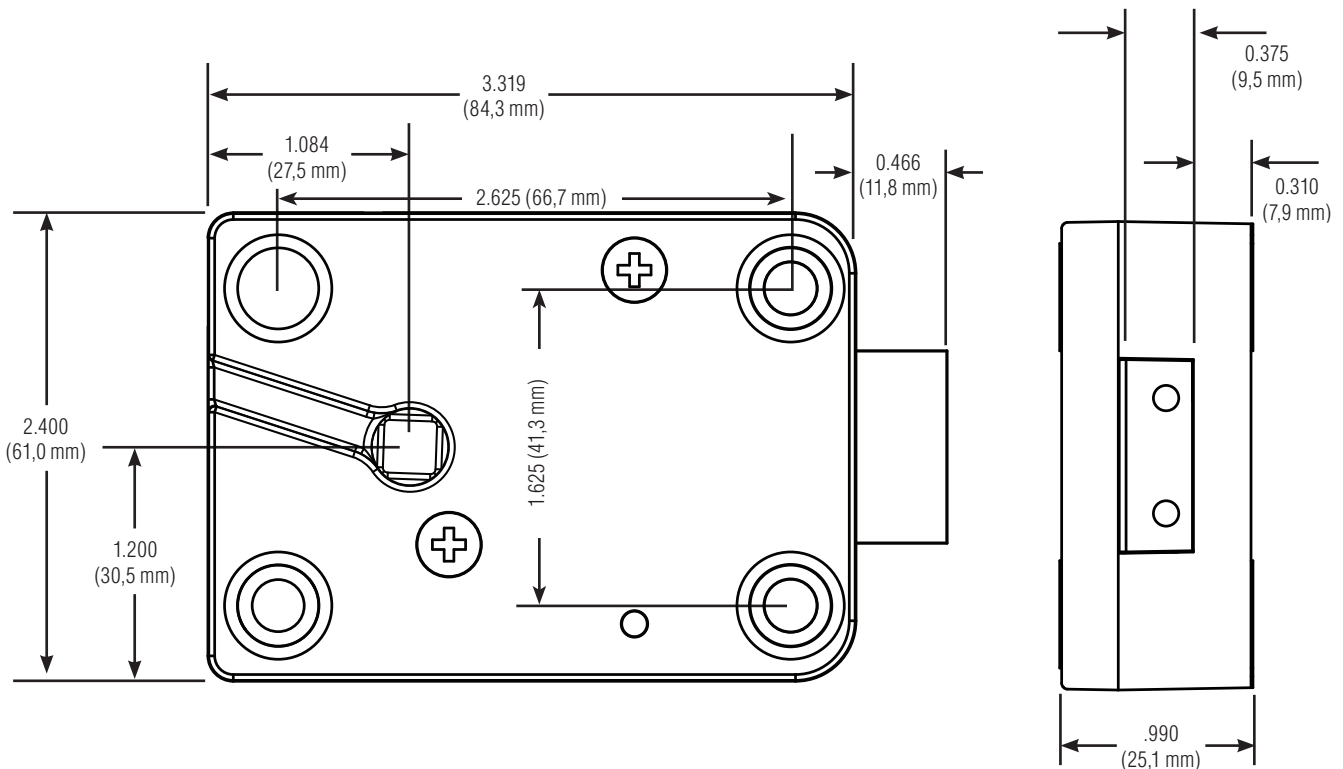

DIMENSIONS—ELECTRONIC VAULT LOCK CASE

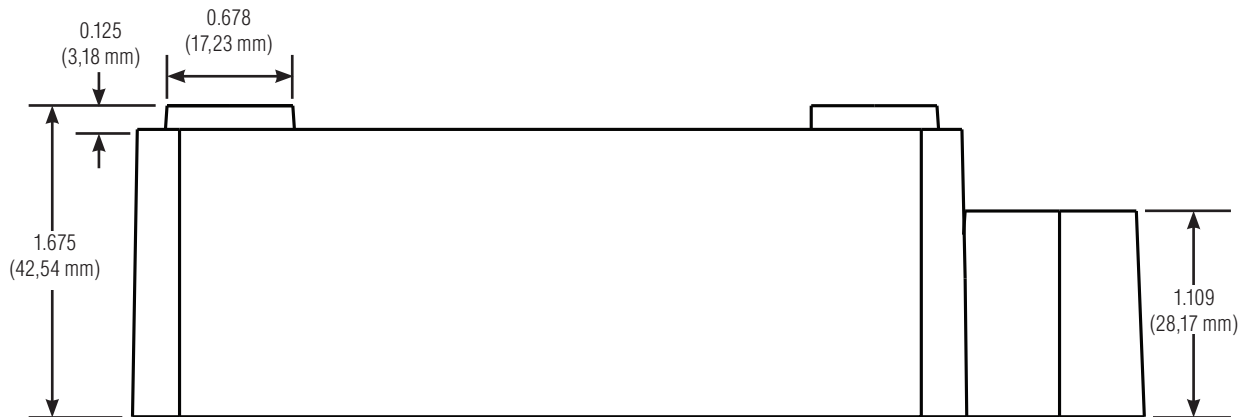
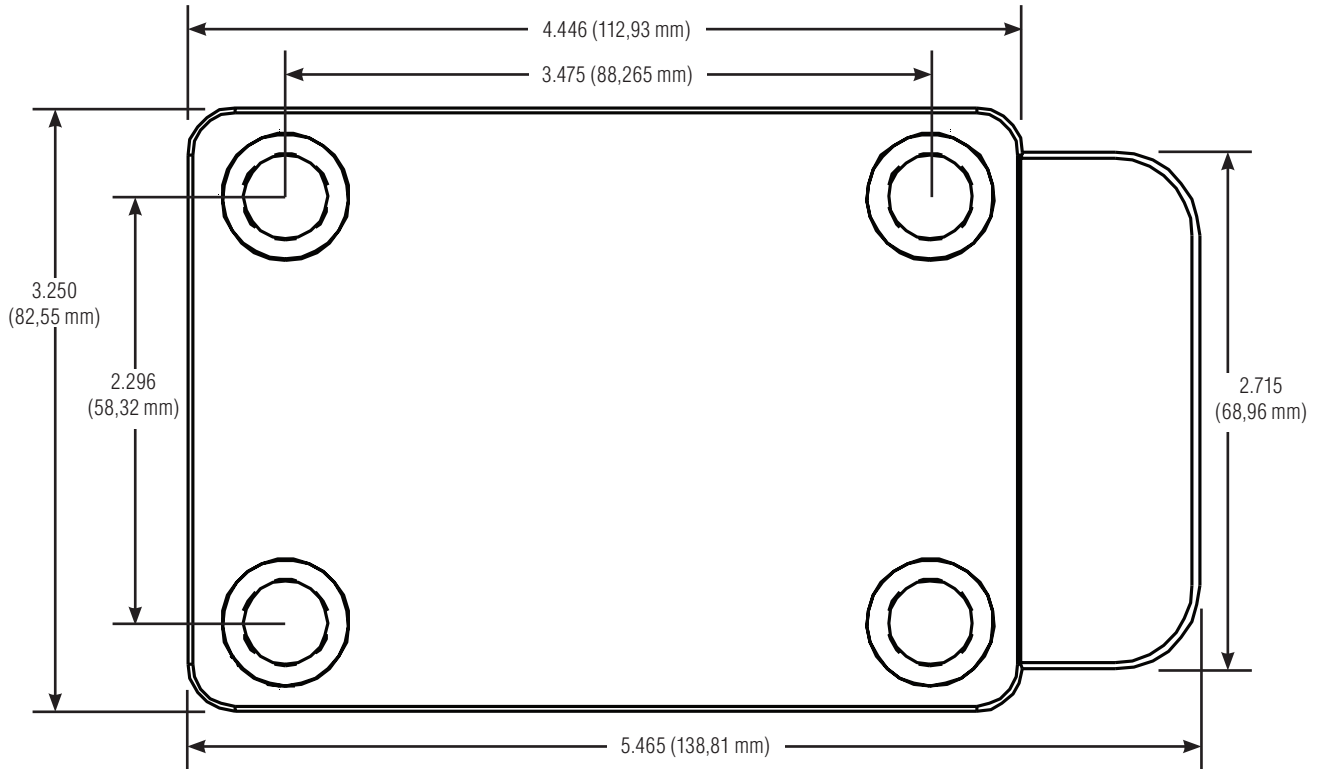

DIMENSIONS—STANDARD SIZE MECHANICAL LOCK CASE

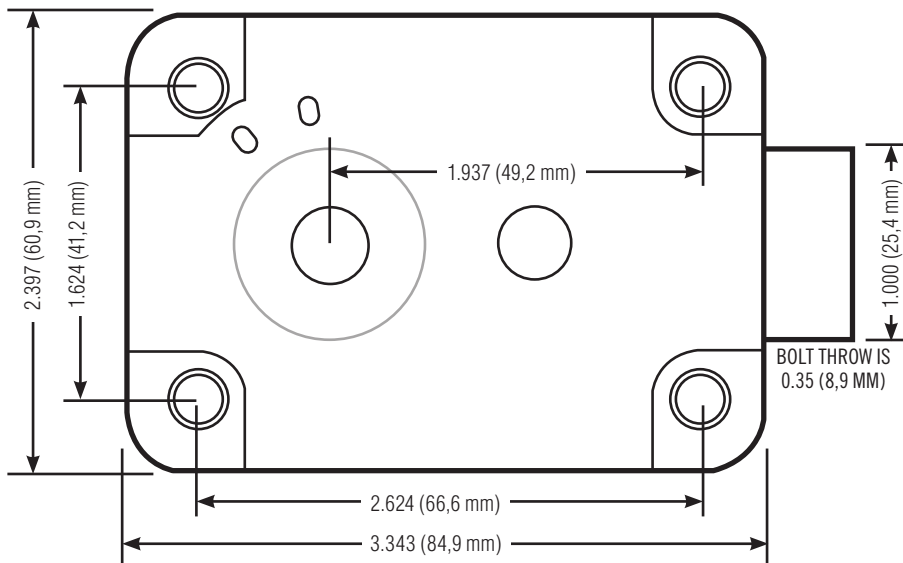

THE DIMENSIONS LISTED ABOVE ARE VALID FOR ALL 2937, 6600, 6700, 8400, AND 8500 SERIES LOCKS.

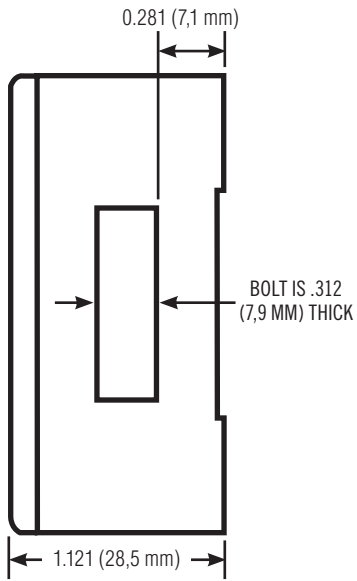

2937, 6600, AND 6700, 8500 SERIES 3-WHEEL LOCKS

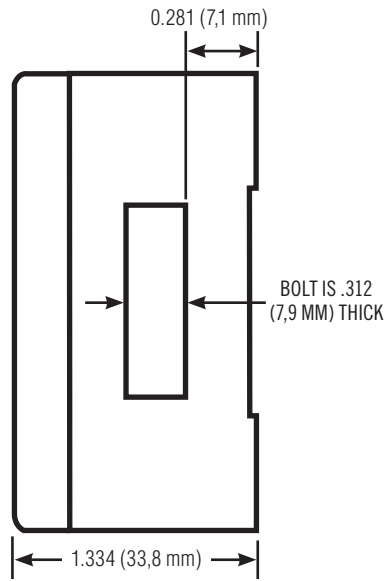

6600 AND 6700 SERIES 4-WHEEL LOCKS

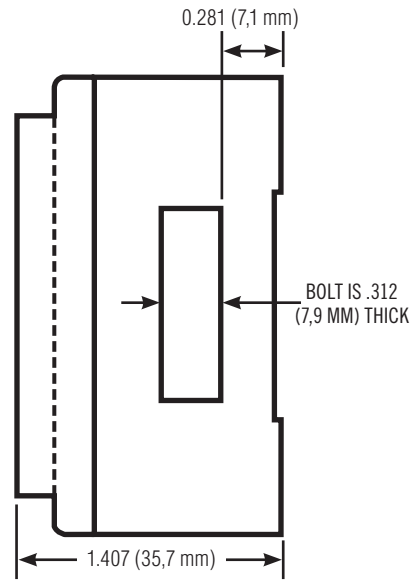

8400 SERIES 3-WHEEL LOCKS

DIMENSIONS—STANDARD SIZE MECHANICAL LOCK BOLTS

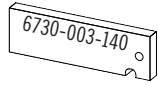

6730-003-140 Extra Long Brass Bolt—Extends 2.461" (62,5 mm) from end of lock case when locked, 2.109" (53,6 mm) from case when unlocked.



6730-003-074 Long Brass Bolt—Extends 0.961" (24,4 mm) from end of lock case when locked, 0.609" (15,5 mm) from case when unlocked.

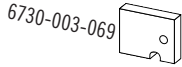

6730-003-069 Standard Brass Bolt—Extends 0.461" (11,7 mm) from end of lock case when locked, 0.109" (2,8 mm) from case when unlocked.



6730-003-166 Metric Tapped Brass Bolt—Extends 0.461" (11,7 mm) from end of lock case when locked, 0.109" (2,8 mm) from case when unlocked. Bolt is drilled and tapped to a depth of 10 mm for two 4 mm - 7 pitch machine screws.



6730-003-167 Short Tapped Brass Bolt—Extends 0.352" (8,9 mm) from end of lock case when locked. Retracts flush to lock case. Bolt is drilled and tapped to a depth of 3/8" (9,5 mm) for two 10-32 machine screws.

DIMENSIONS—MECHANICAL VAULT LOCK CASE

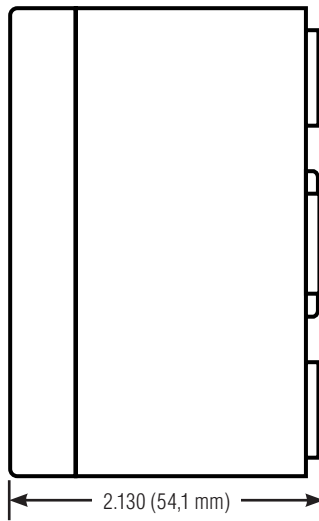
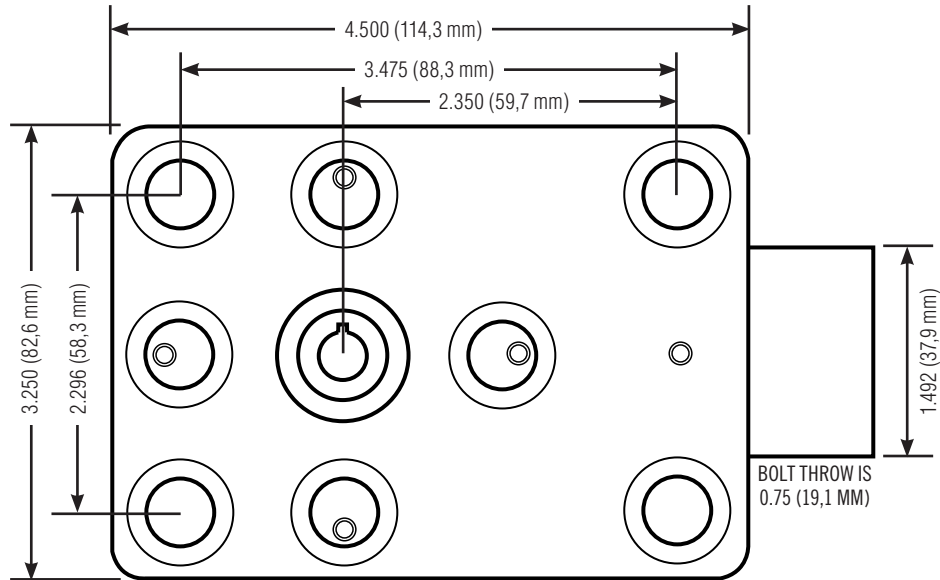

CASE HEIGHT IS 2.250 (57,15 MM) IF
GEAR PLATE IS USED FOR INDIRECT DRIVE
APPLICATIONS

SPACINGS AND DEPTHS FOR SAFE DEPOSIT LOCKS

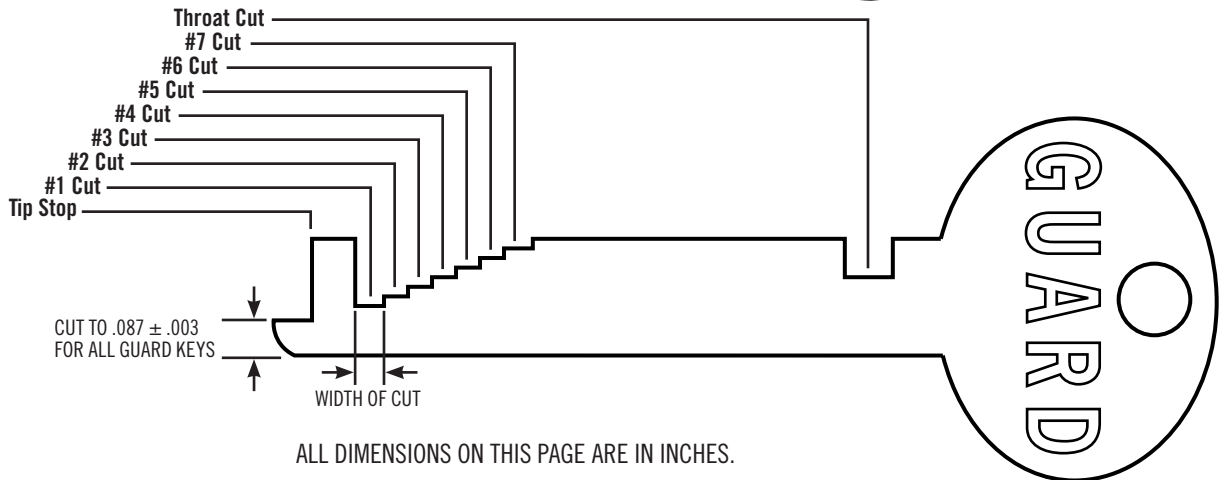
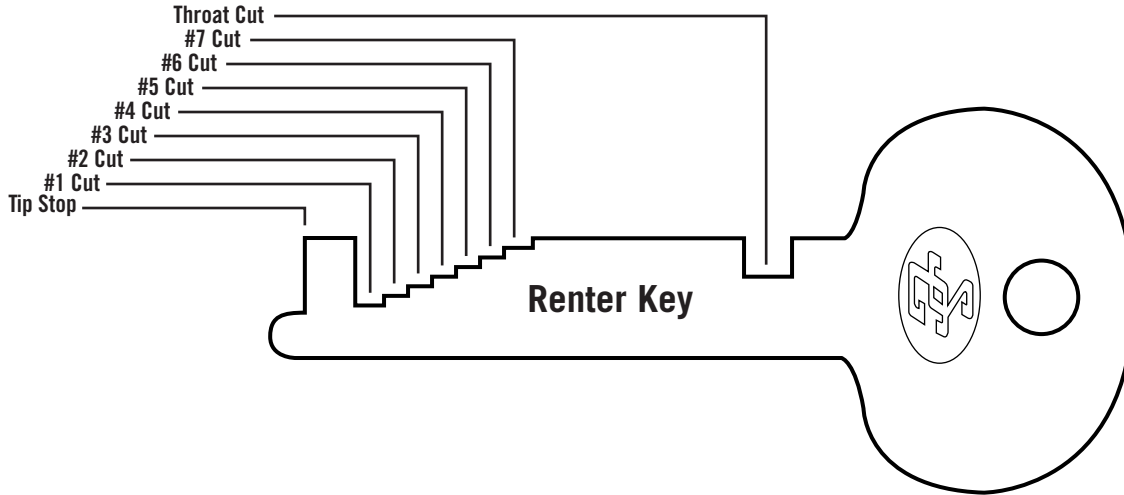

ALL DIMENSIONS ON THIS PAGE ARE IN INCHES.

Spacing is from Tip Stop to Center of Cut

Root Depths are Measured from Bottom of Blank to the Bottom of the Cut

LOCK SERIES	CUT SPACING	Spacing is from Tip Stop to Center of Cut								Root Depths are Measured from Bottom of Blank to the Bottom of the Cut							
		1ST CUT	2ND CUT	3RD CUT	4TH CUT	5TH CUT	6TH CUT	7TH CUT	THROAT CUT	DEPTH 0	DEPTH 1	DEPTH 2	DEPTH 3	DEPTH 4	DEPTH 5	DEPTH 6	DEPTH 7
41XX	FROM TIP STOP	.167	.222	.271	.319	.367	.415	.470	1.0875	.314	.298	.278	.258	.238	.218	.198	.178
	WIDTH OF CUT	.066	.052	.052	.052	.052	.052	.066	.105								
45XX Renter	FROM TIP STOP	.167	.222	.271	.319	.367	.415	.470	1.0875	.314	.298	.278	.258	.238	.218	.198	.178
	WIDTH OF CUT	.066	.052	.052	.052	.052	.052	.066	.105								
45XX Guard	FROM TIP STOP	.167	.222	.271	.319	.367	.415	.470	1.0775	.275	.255	.235	.215	.195	.175	.155	.135
	WIDTH OF CUT	.066	.052	.052	.052	.052	.052	.066	.105								
4231 Renter	FROM TIP STOP	.167	.222	.271	.319	.367	.422		1.0875	.314	.298	.278	.258	.238	.218	.198	.178
	WIDTH OF CUT	.066	.052	.052	.052	.052	.066		.105								
4231 Guard	FROM TIP STOP	.167	.222	.271	.319	.378			1.0775	.275		.235		.195		.155	
	WIDTH OF CUT	.066	.052	.052	.052	.066			.105								
44XX Renter	FROM TIP STOP	.167	.222	.271	.319	.367	.422		1.0875	.314	.298	.278	.258	.238	.218	.198	.178
	WIDTH OF CUT	.066	.052	.052	.052	.052	.066		.105								
44XX Guard	FROM TIP STOP	.167	.222	.271	.319	.378			1.0775	.275		.235		.195		.155	
	WIDTH OF CUT	.066	.052	.052	.052	.066			.105								

DIMENSIONS—4200 AND 4400 SERIES SAFE DEPOSIT LOCKS

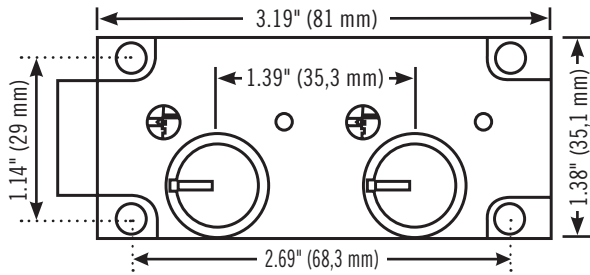

4420—designed for matchwork to all Corbin guard keys (RH model shown here)

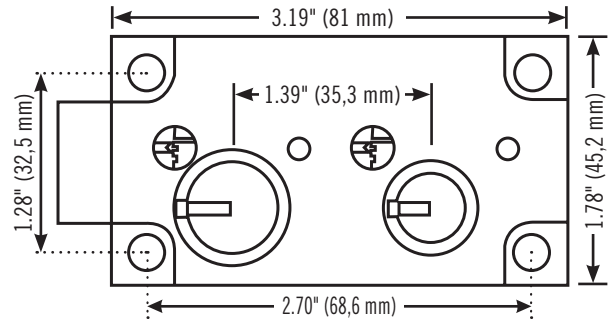

4442—designed for matchwork to the Diebold 175 series (RH model shown here)

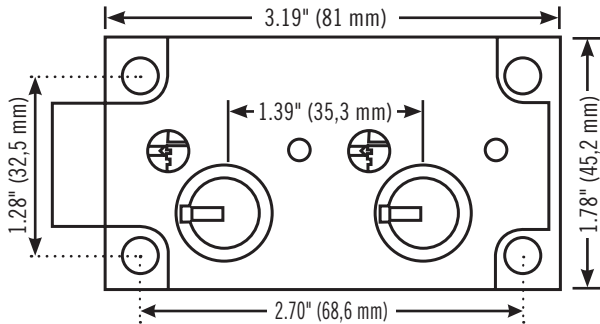

4231—designed for matchwork to the Yale SY3 guard key (RH model shown here)

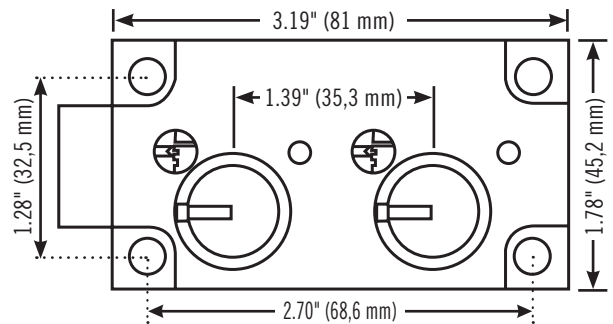

4443—designed for matchwork to the Mosler 5700 series (RH model shown here)

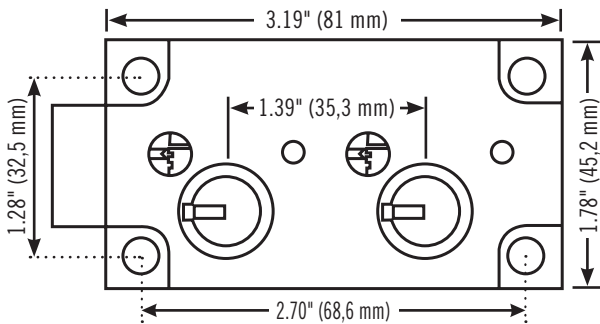

4440—a standard of the safe deposit industry since 1922 (RH model shown here)

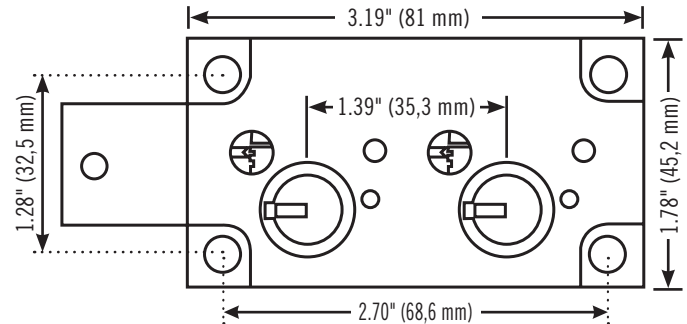

4444—designed for B and C-rate depository safe doors (available RH only)

BOLT OFFSET DIMENSIONS FOR ALL 4200 AND 4400 SERIES SAFE DEPOSIT LOCKS

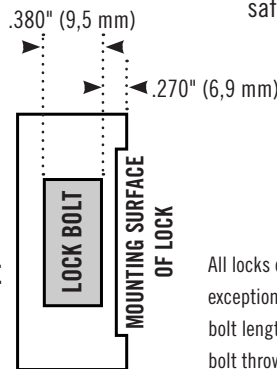

All locks on this page (with the exception of the 4444) have an extended bolt length of .40" (10,2 mm), with a bolt throw of .31" (7,9 mm).

DIMENSIONS—4100 SERIES CABINET LOCK

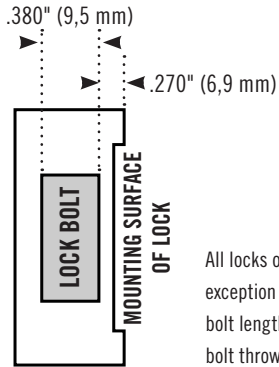
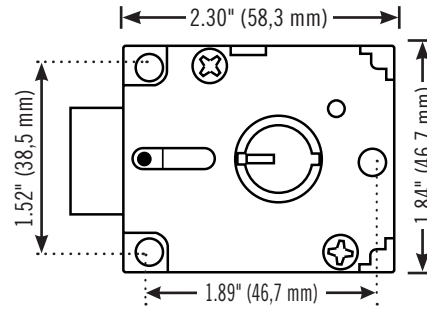

**BOLT OFFSET
DIMENSIONS FOR
ALL 4100 AND
4500 SERIES SAFE
DEPOSIT LOCKS**

All locks on this page (with the exception of the 4444) have an extended bolt length of .40" (10,2 mm), with a bolt throw of .31" (7,9 mm).

DIMENSIONS—4500 SAFE DEPOSIT LOCK

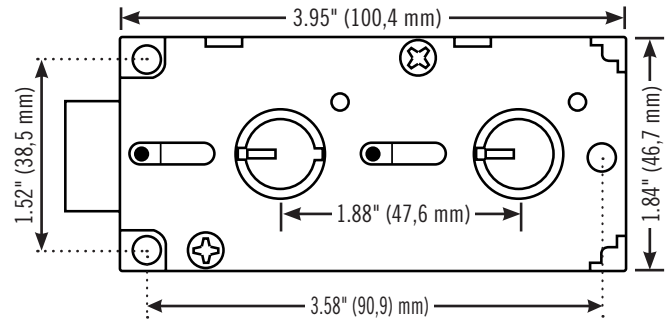

SARGENT AND GREENLEAF®

A Subsidiary of Stanley Security Solutions, Inc.



Sargent & Greenleaf

One Security Drive, Nicholasville, Kentucky 40356
Phone (800) 826-7652 FAX (800) 634-4843
Phone (859) 885-9411 FAX (859) 887-2057

Sargent & Greenleaf S.A.

9, chemin du Croset, 1024 Ecublens, Switzerland
Phone 41 21 694 34 00 FAX 41 21 694 34 09

S&G® products are sold throughout the world. Contact your nearest Sargent and Greenleaf Distributor for pricing and availability on any of our products. For the latest product information and a complete listing of S&G® distributors, please visit our website:

www.sargentandgreenleaf.com

Packaging

Your distributor may choose to repackage items or sell products as single units or in lots containing fewer items than the manufacturer's standard package quantities. Check with your distributor for quantities and pricing before placing an order.

WARRANTY

Seller warrants that for one year* from the date of shipment from Seller's point of manufacture, the goods shall be free from defects in material and workmanship, provided the goods are normally and properly used according to the Seller's written instructions.

THIS WARRANTY IS EXPRESSLY MADE IN LIEU OF ANY AND ALL OTHER WARRANTIES, EXPRESS OR IMPLIED. S&G DOES NOT WARRANT THAT THE GOODS ARE MERCHANTABLE OR FIT FOR ANY PARTICULAR PURPOSE EXCEPT AS EXPRESSLY PROVIDED HEREIN.

Seller's entire liability and Buyer's exclusive remedy in the event that the goods do not conform to the foregoing warranty shall be Seller's repair or replacement of the goods (including payment of freight costs to and from point of Manufacture).

UNAUTHORIZED USE OF COMPONENTS NOT MANUFACTURED BY THE SELLER IN CONJUNCTION WITH SELLER'S PRODUCTS INVALIDATES THE WARRANTY. ANY MODIFICATIONS TO PRODUCTS NOT PERFORMED BY S&G INVALIDATE THE WARRANTY. SELLER SHALL HAVE NO LIABILITY FOR ANY CONSEQUENTIAL, INCIDENTAL, INDIRECT OR SPECIAL DAMAGES. SELLER DOES NOT WARRANT ITS LOCK PRODUCTS TO BE IMPERVIOUS TO FORCIBLE OR SURREPTITIOUS ENTRY, AND SELLER SHALL HAVE NO LIABILITY FOR DAMAGE TO OR LOSS OF PROPERTY SOUGHT TO BE PROTECTED BY ANY SUCH LOCK.

*6100 series electronic locks, 6300 series electronic locks, Titan 2006/2007 series electronic locks, 6730 series mechanical combination locks, 2740 electromechanical locks, and Environmental Padlocks carry a two year warranty. Arm-A-Dor® devices carry a five year parts warranty on mechanical components and a one year parts warranty on the alarm components.

Technical information and information regarding certifications in this publication are accurate to the best of our ability at the time of publication. Sargent & Greenleaf does not, however, warrant the accuracy of such information and assumes no responsibility for the application of such information published in this catalog.





Corporate Headquarters: One Security Drive, Nicholasville, KY 40356, USA
Telephone: 859-885-9411 Fax 859-887-2057

European Headquarters: 9, chemin du Croset, 1024 Ecublens, Switzerland
Telephone: 41 21 694 34 00 Fax 41 21 694 34 09